

DARRAN

# Spaces

price list | effective January 2016 | updated 1.19.17



**SPACES PRICE LIST REVISIONS**

<b>DATE</b>	<b>PAGE</b>	<b>MODIFICATION</b>	<b>DESCRIPTION</b>
7.20.16	ALL	Removed Finish	Removed discontinued finish GRC Caramel Cherry
7.21.16	58	Updated Incorrect Price	Updated SPC9329WH332W from 2574 to 3574
7.21.16	29-31	Added Options	Added flush cut options
8.26.16	N/A	Edited Tackboards	Half size overhead tackboard SKUs and sizes have been corrected

**TABLE OF CONTENTS**

Product index ..... 2

General Information ..... 4

Limited Lifetime Warranty ..... 5

Damages | Returns | Reparis ..... 6

Ordering Information ..... 7

GSA Customer Information ..... 8

Freight..... 9

Features & Advantages ..... 10

Finishes | Specifications..... 12

Edges | Pulls ..... 13

Grommets | Grommet Reference ..... 14

Ganging | Height Reference ..... 15

Modesty Reference | Doors | Grain Direction ..... 16

Drawer Dimensions | FILING Reference ..... 17

Double Pedestal Desk ..... 18

Table Desk..... 20

Single Pedestal Desk ..... 21

Conference Desk ..... 23

Runoff Desk ..... 25

Returns..... 29

Bridges ..... 32

Corner Units..... 33

Freestanding Credenzas..... 34

Workstation Credenzas..... 41

Pedestals ..... 44

Single Height Freestanding Overheads ..... 45

Double Height Freestanding Overheads ..... 47

Overhead Accessories..... 49

Single Height Wall Hung Overheads ..... 53

Double Height Wall Hung Overheads ..... 56

Wall Hung Accessories ..... 59

Overhead Half Towers ..... 64

Overhead Bookcases ..... 68

Vertical Half Towers ..... 70

Vertical Full Towers ..... 74

Bookcases..... 77

Options ..... 78

Power and Data..... 101

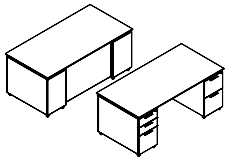

PAGE 18  
DOUBLE PEDESTAL DESKS

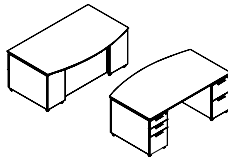

PAGE 19  
DOUBLE PEDESTAL DESKS

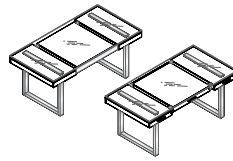

PAGE 20  
TABLE DESKS

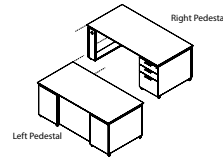

PAGE 21  
WORKSTATION DESKS

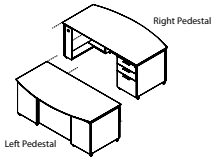

PAGE 22  
WORKSTATION DESKS

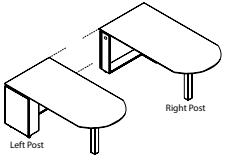

PAGE 23  
WORKSTATION CONFERENCE DESKS

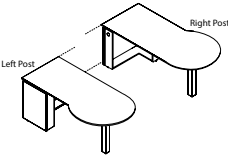

PAGE 24  
WORKSTATION CONFERENCE DESKS

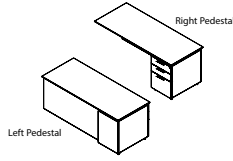

PAGE 25  
WORKSTATION RUNOFF DESKS

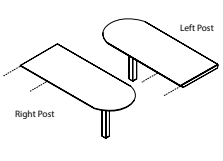

PAGE 26  
WORKSTATION RUNOFF DESKS

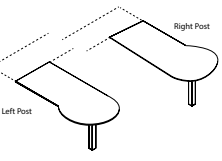

PAGE 27  
WORKSTATION RUNOFF DESKS

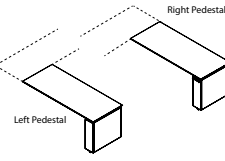

PAGE 28  
WORKSTATION RUNOFF DESKS

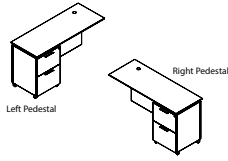

PAGE 29  
"L" WORKSTATION RETURNS

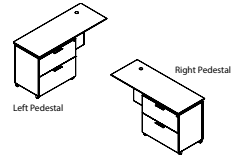

PAGE 30  
"L" WORKSTATION RETURNS

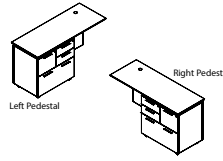

PAGE 31  
"L" WORKSTATION RETURNS

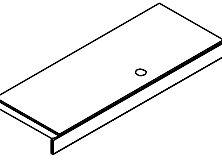

PAGE 32  
WORKSTATION BRIDGES

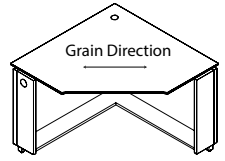

PAGE 33  
CORNER UNIT

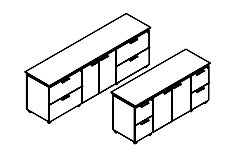

PAGE 34  
CRENZAS

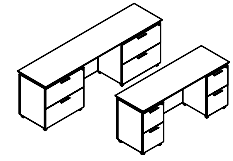

PAGE 35  
CRENZAS

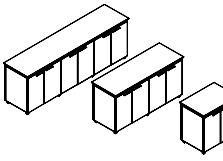

PAGE 36  
CRENZAS

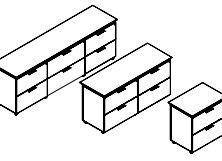

PAGE 37  
LATERAL FILE CRENZAS

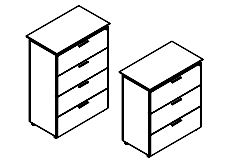

PAGE 38  
LATERAL FILE CRENZAS

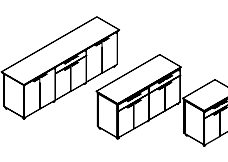

PAGE 39  
CONFERENCE CRENZAS

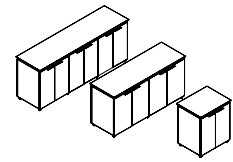

PAGE 40  
CONFERENCE CRENZAS

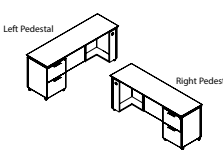

PAGE 41  
WORKSTATION CRENZAS

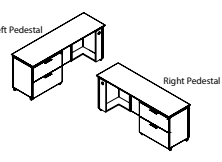

PAGE 42  
WORKSTATION CRENZAS

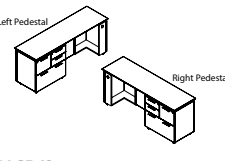

PAGE 43  
WORKSTATION CRENZAS

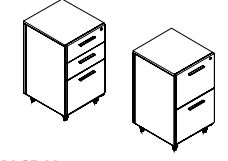

PAGE 44  
MOBILE PEDESTALS

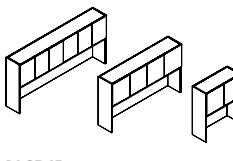

PAGE 45  
SINGLE STORAGE OVERHEAD CONSOLE

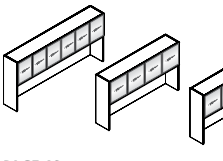

PAGE 46  
SINGLE STORAGE OVERHEAD CONSOLE

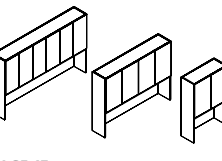

PAGE 47  
DOUBLE STORAGE OVERHEAD CONSOLE

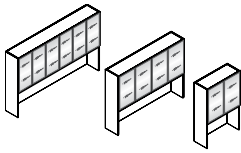

PAGE 48  
DOUBLE STORAGE OVERHEAD  
CONSOLE

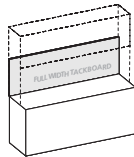

PAGE 49  
OVERHEAD TACKBOARDS

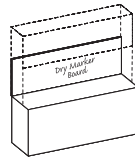

PAGE 50  
OVERHEAD DRY MARKER BOARDS

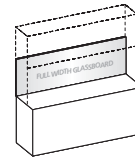

PAGE 51  
OVERHEAD GLASSBOARDS

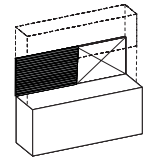

PAGE 52  
OVERHEAD SLAT WALL

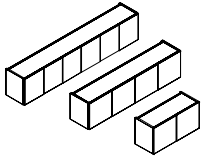

PAGE 53  
SINGLE HEIGHT WALL HUNG  
OVERHEADS

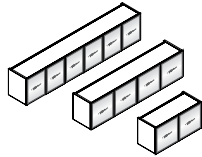

PAGE 54  
SINGLE HEIGHT WALL HUNG  
OVERHEADS

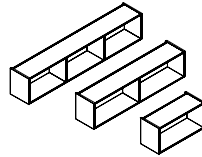

PAGE 55  
SINGLE HEIGHT WALL HUNG  
OVERHEADS

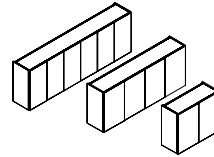

PAGE 56  
DOUBLE HEIGHT WALL HUNG  
OVERHEADS

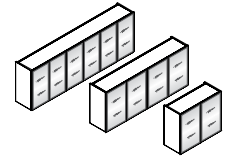

PAGE 57  
DOUBLE HEIGHT WALL HUNG  
OVERHEADS

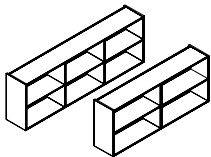

PAGE 58  
DOUBLE HEIGHT WALL HUNG  
OVERHEADS

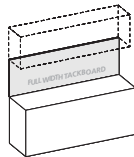

PAGE 59  
WALL HUNG TACKBOARDS

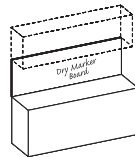

PAGE 60  
WALL HUNG DRY MARKER  
BOARDS

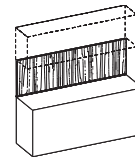

PAGE 61  
WALL HUNG VENEER PANELS

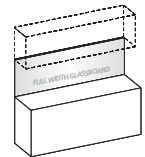

PAGE 62  
WALL HUNG GLASSBOARDS

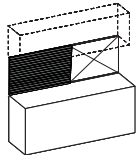

PAGE 63  
WALL HUNG SLAT WALL

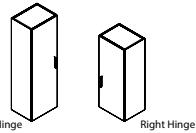

PAGE 64  
OVERHEAD TOWER EXTENSION

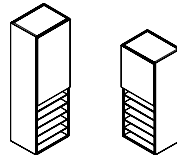

PAGE 65  
SIT-ON TOWER EXTENSION

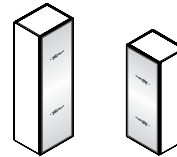

PAGE 66  
SIT-ON TOWER EXTENSION

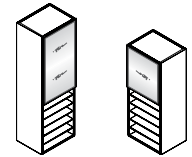

PAGE 67  
SIT-ON TOWER EXTENSION

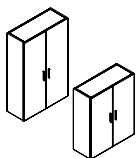

PAGE 68  
OVERHEAD BOOKCASE CONSOLE

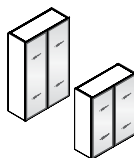

PAGE 69  
OVERHEAD BOOKCASE CONSOLE

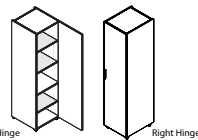

PAGE 70  
FREESTANDING HALF TOWERS

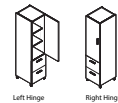

PAGE 71  
FREESTANDING HALF TOWERS

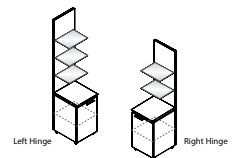

PAGE 72  
DISPLAY STORAGE TOWER

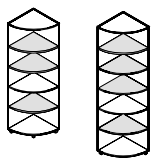

PAGE 73  
BOOKCASE TOWERS

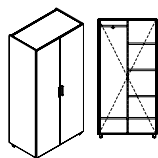

PAGE 74  
FREESTANDING FULL TOWERS

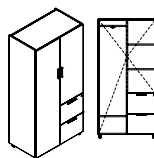

PAGE 75  
FREESTANDING FULL TOWERS

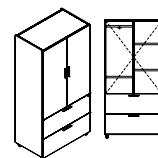

PAGE 76  
FREESTANDING FULL TOWERS

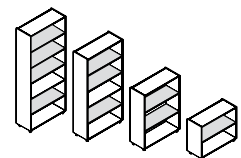

PAGE 77  
FREESTANDING BOOKCASES



All DARRAN products are proudly manufactured in the U.S.A.

**BUILT TO ORDER**

Manufactured per order the way you want it, including modifications.

**FULLY ASSEMBLED**

Unless otherwise noted, all products are fully assembled and ready to use, including add-on options.

**PERFORMANCE TESTED**

All products are tested to ensure performance exceeds BIFMA / ANSI standards.



**GREEN CERTIFIED**

DARRAN has been committed to improving indoor air quality of office buildings since 1996. Since then, finish technology has allowed our commitment to continue with products that are air quality Certified Green.

DARRAN is proud to announce that all in veneer, laminate, and guest seating are MAS Certified Green for complying with the ANSI/BIFMA X 7.1 standard / LEED 4.5 Standard for low –VOC emitting Furniture.

MAS is an independent emission testing laboratory that is ISO 17025 compliant using ASTM, ANSI and CEN methods. MAS is a true 3rd party certification through NSF International to BIFMA standards and California’s ARB formaldehyde standard. Certification of compliance under the Low – VOC emitting Furniture testing, qualifies products for LEED 4.5 credits.



**FINISH TECHNOLOGY**

DARRAN has continued its partnership with AkzoNobel Chemicals ([www.akzonobel.com](http://www.akzonobel.com)) to develop a new finish technology further improving indoor air quality with a coating that meets today’s environmental standards and supports LEED buildings.

ENVI-CT (Environmental Coatings Technology) utilizes advanced European finish technology to deliver a high-end furniture coating with superior performance in appearance and durability, allowing DARRAN to deliver more sustainable products to our customers.

*ENVI-CT Advantages:*

- › ENVI-CT is a re-engineered high performance Coatings Top Coat
- › Exceptional hardness and clarity
- › Highly resistant to solvents and chemicals
- › Plasticizer Migration resistant
- › Excellent UV inhibitors for maximum color resistance
- › Exceeds current and proposed future Federal and State air quality requirements
- › Field Repairable
- › Dynamic chamber emissions tested and certified compliant to ANSI/BIFMA X 7.1 Standard / LEED 4.5 Standard for low – VOC emitting furniture.
- › Standard with Anti-microbial additive.

**ADVANTAGES**

DARRAN has upgraded the standard Anti-microbial protection, to , the latest in Silver Ion Technology. DARRAN collaborated with the world’s leader in finishing materials, to formulate an additive that will inhibit the growth of mold, mildew, fungus and bacteria on wood surfaces. This additive infuses Silver Ions into DARRAN’s ENVI-CT (Environmental Coatings Finish Technology), creating a protective surface for the life of the furniture. The best part - is standard on all DARRAN Caseloads for no additional fee.



## LIMITED LIFETIME WARRANTY

DARRAN Furniture Industries, Inc. ("DARRAN") warrants that each piece of furniture manufactured in its North Carolina Facilities will be free from defects in material and workmanship for as long as the original purchaser owns and uses the product. Subject to the limitations and exclusions herein, DARRAN, at its discretion and as the sole remedy under the DARRAN Limited Lifetime Warranty, will replace or repair a defective product or components with comparable product or components free of charge. This warranty is made only to the original purchaser from an authorized DARRAN dealer, for as long as that original purchaser owns and uses the product.

### LIMITATIONS: USE / CARE

- › Warranty is limited to normal single shift use.
- › Warranty is limited to generally accepted care and maintenance of natural wood products and environments.
- › Natural wood surfaces are subject to denting, scratching, and gauging if not properly used and cared for. Warranty is subject to use and care in accordance with the use and care instructions provided in the Product Care section of this site (including, but not limited to, the care and maintenance guide downloads linked thereon), available at [www.darran.com/product-care](http://www.darran.com/product-care), which are incorporated herein by reference.

### LIMITATIONS: MATERIALS / COMPONENTS

- › Laminates, Veneers / Finishes - 10 Years
- › Electrical lamps, Ballasts, Transformers - 5 Years
- › Fabrics, Pneumatic lifts, Foam - 5 Years
- › Custom products built to customers specifications - 3 Years

### WARRANTY EXCLUSIONS

*Damage identified as carrier or installer related.*

- › Normal wear and tear of wood products during course of ownership.
- › Color, grain, or texture of natural wood materials, laminates, and other covering materials.
- › Damages or failures resulting from misuse, abuse, negligence, improper care, modifications, or relocation.
- › Non Commercial use or locations.
- › So-called "ghost" indentions and similar damage caused by the failure to use appropriate desk or writing pads.

All Warranty Claims are subject to DARRAN-approved inspections. Disputes may involve independent third-party evaluation

### QUALITY ASSURANCE

DARRAN manufactures in accordance with the standards set by Architectural Woodwork Institute (AWI) for Quality Standards.

Every unit produced at DARRAN is completely inspected by an independent quality control team located within each plant whose emphasis is on assembly, finish, and final inspections with empowerment to stop any unit not meeting DARRAN's high quality standards.

### LIGHT AND NATURAL FINISHES

The beauty of veneer and all wood products comes from the variations created by nature including color, grain, and texture.

These variations are not considered defects and DARRAN's Limited Lifetime Warranty does not cover color, grain and texture variations associated with natural wood and grain seen in any finish color. DARRAN sets standards for veneer selections; however, variations, especially apparent in light/natural finishes, will occur from one piece to another even if they are finished at the same time.

Finishes such as Clear Maple, Light/Gunstock Walnut, and Clear/Caramel Cherry will display more natural characteristics due to their light stain. Grain, pattern and color from unit to unit are not guaranteed or warranted and products will not be replaced due to these variations. Exposure to light and age will cause darkening of natural wood products; therefore DARRAN cannot guarantee or warrant finish match of new products being placed with existing products in the field.

### GLASS

Use of glass overlays on surfaces will void DARRAN's Limited Lifetime Warranty, unless the overlay is installed and maintained in strict accordance with DARRAN's instructions. If an overlay is to be used, please contact DARRAN for installation and maintenance instructions.

### GENERAL

Performance questions will be tested to generally accepted practices and AWI guidelines and standards for wood veneer furniture. To obtain performance of the Limited Lifetime Warranty, the purchaser should contact in writing the authorized DARRAN representatives or current dealer who sold the product to the purchaser or mail the warranty claim to:

Warranty Department  
DARRAN Furniture Industries, Inc.  
P.O. Box 7614  
High Point, NC 27264  
Telephone: 336-861-2400      Toll Free: 800-334-7891  
email: [warranty@darran.com](mailto:warranty@darran.com)

EXCEPT FOR THE LIMITED LIFETIME WARRANTY EXPRESSLY DESCRIBED HEREIN, DARRAN MAKES NO OTHER REPRESENTATION OR WARRANTY OF ANY KIND, EXPRESS OR IMPLIED. DARRAN MAKES NO WARRANTY OF MERCHANTABILITY OR FITNESS FOR A PARTICULAR PURPOSE, AND DARRAN WILL NOT UNDER ANY CIRCUMSTANCES BE LIABLE FOR ANY INCIDENTAL OR CONSEQUENTIAL DAMAGES, OR ANY INDIRECT OR SPECIAL DAMAGES.

### THE WARRANTY AS STATED ABOVE, SUPERSEDES ALL PREVIOUS WARRANTIES

**NO HASSLE FREIGHT DAMAGED MERCHANDISE**

DARRAN products are packed in specially designed cartons and padding that protects all edges and corners from damage. This is proven by an industry low damage rate of .0030% per total pieces shipped.

For qualified freight damage claims DARRAN will take responsibility for the claim and remedy processes including assuming total cost coverage from claim settlements.

(Some items may not qualify. Contact Factory for specific details.)

**QUALIFIED CLAIM CONDITIONS****VISIBLE CARTON DAMAGE**

1. Take digital pictures of the damaged carton and damaged furniture if visible damage is found upon delivery at the dock
2. Open all cartons with puncture or crushed corner damage.
3. Note any damage to the goods on the Carrier's freight bill as number of pieces damaged.

**CONCEALED DAMAGE**

1. Take digital pictures of the furniture as it sits partially unpacked. Also, photograph external and internal carton materials that correspond with the damaged area on the product.
2. Carton and damaged unit(s) must be located at the location matching the original delivery address for Carrier inspection.
3. Digital pictures must be provided of the damaged furniture and carton materials

For qualified claims per above contact DARRAN Customer Service Department at 1-800-334-7891 or complete DARRAN's online warranty report form within the 15 day limit. [www.darran.com/warrantyreport](http://www.darran.com/warrantyreport)

**NON-QUALIFIED CLAIM CONDITIONS**

1. Deliveries made to non-dock locations
2. Claims made after furniture is installed and/or removed from original delivery location
3. Carton and padding has been discarded
4. Carrier used was not DARRAN approved
5. Inspection reveals questionable damages

**REPLACEMENT ORDERS**

Replacement orders entered without replacement tagging or factory authorization is considered a new order without dispute, therefore full payment is expected and will be collected.

**RETURN SHIPMENTS**

DARRAN will not accept return of merchandise without a signed RA (return authorization) form.

DARRAN will specify the carrier to be used. Return bills of lading must be marked "Class 125" freight rate and a copy of the RA should be used as a packing list. All returns must be received by DARRAN within 30 days of the RA date or the products will be considered accepted by the customer.

All products being returned must be properly packed and protected to avoid freight damage. Whenever possible, use the original cartons in which the merchandise was shipped. Freight

damage, signs of usage, missing parts, etc., will result in an adjustment of any credit to be issued.

DARRAN will issue RA's for the following reasons:

1. Manufacturing defect (inspection required)
2. Order processing error by DARRAN
3. Shipping error
4. Mismatched carton / merchandise

**SPECIFICATION CHANGES**

We reserve the right to change without notice any dimension, style, or specification of any model in the DARRAN line. Dimensions shown in the price list are nominal. It is the buyer's responsibility to read specification carefully when matching existing goods is desired.

**MANUFACTURING DEFECTS**

Claims of manufacturing defects will not be entertained without prior consultation with DARRAN's warranty department. Unauthorized deduction in payment of invoices will not be allowed without prior factory approval. Unapproved deductions are subject to factor's late payment charges.

**DAMAGE CLAIMS**

Claims of manufacturing damage or freight damage reported as nicks, dents, scratches, etc. after installation of furniture will not be covered under warranty or freight claim.

**ATTENTION:** Damage claims involving glass or stone components must be inspected and damage noted on delivering freight bill to qualify for replacement.

**REPAIR CHARGES**

Factory authorization must be secured from DARRAN's warranty department prior to incurring repair charges. Warranty will utilize DARRAN's National Repair Service through the Furniture Medic Franchise ([www.furnituremedic.com](http://www.furnituremedic.com)).

Repair charge authorizations are based on:

- › Set travel rate
- › Average regional job rate
- › Factory set maximum repair time
- › Falsely reported defect claims are subject to local service charges being charged to dealer/distributor.

**FINISH MAINTENANCE**

Wood office furniture and wood finishes can retain their natural beauty for life if proper care is taken and a stable environment is provided. Fluctuations in humidity and temperature cause panels and solid wood components to expand and contract and may lead to panel warpage and finish "checking" or cracking. Prolonged exposure of furniture to dry heat during winter months should be avoided. Careful examination of interior wood trim may indicate a damaging dry environment. If open joints, splits and cracks are appearing in trimwork consult with a HVAC professional for appropriate remedy.

DARRAN finishes are field repairable should damage occur. Professional furniture repair services are recommended. Regular cleaning with a non-silicone polish is recommended.



**ORDERING**

All orders should be emailed, mailed or transmitted by fax to:

DARRAN Furniture Industries, Inc.  
P.O. Box 7614  
High Point, NC 27264  
email: orders@darran.com  
Fax: 336-861-6485

DARRAN will only accept orders from authorized Dealers. All orders must be accurate and detailed. All Quick Ship orders must contain Quick Ship product ONLY. Orders should be separated and submitted according to lead time. Orders must contain Quick Ship code "QS" or have designated Quick Ship lead time to ensure correct order entry. Orders that contain multiple lead time products will be entered as one order and scheduled with the most extended lead time.

List product by office and tag accordingly. DARRAN will key alike all products under the office tag. Failure to assign and tag may result in random key number assignments. Keying is field changeable.

**CREDIT APPROVAL**

All orders are subject to credit approval for open account. All new accounts must be approved by a local DARRAN Sales Representative and should submit current financial information and trade references to:

DARRAN Furniture Industries, Inc. ATTN: Credit Department  
P.O. Box 7614  
High Point, NC 27264  
Telephone: 336-861-2400 Toll Free: 800-334-7891  
Fax: 336-861-2512

Orders submitted without accounts pre-approval or credit approval are subject to acceptance with lead times scheduled only after approval dates.

**LEAD TIME SCHEDULE**

DARRAN cannot assign a firm lead time until Credit approval and order accuracy are complete. Extended lead times due to credit or information delays are the responsibility of the Buyer.

**ORDER DELAY / HOLD**

Due to the committed manufacturing cost on Quick Ship processes, DARRAN cannot delay or hold orders, either in process or after completion.

**CANCELLATION AND ORDER CHANGES - FEES**

Acknowledged orders are considered firm orders and therefore not subject to cancellation or change. However, in the event we are able to stop an order prior to manufacturing process, we will consider cancellation or changes with a reprocessing fee of \$40.00 Net. Exceptions: Quickship orders cannot be changed or canceled after the 3rd business date after acknowledgment. Qualified changes/cancellations will be assessed a \$40.00 Net processing fee.

Changes or cancellation of order with special options or custom quoted items are also subject to additional material and vendor fee costs, plus a DARRAN special/custom reprocessing fee of \$100 NET.

**ORDER MOVEUPS**

Should an original scheduled ship date need to be improved, the Factory must be contacted 15 business days prior to the desired ship date. Move ups are subject to schedule availability.

**ORDER ACKNOWLEDGMENT**

Upon credit approval your order will be acknowledged and identified by an order number. When making reference to your order, please use this order number. Your acknowledgment is a detailed description of our interpretation of your order, pricing, shipping information, and estimated delivery date.

If you have not received an Acknowledgment within 10 Days of order issue, contact Customer Service immediately. All Quick Ship order acknowledgments will be faxed or emailed upon request to speed processing. Please read your acknowledgment carefully for correctness and notify DARRAN immediately of any discrepancies. Failure to notify relieves DARRAN from error liability.

Order acknowledgment is the final agreement between DARRAN and the customer superseding all previous communications regarding the order. DARRAN will not be responsible for errors made on orders placed by phone without written confirmation.

**SELLING INFORMATION**

Possession of this price list does not in itself constitute the right to sell DARRAN products. DARRAN products are sold and distributed through authorized dealerships. Contact factory for a listing of local representatives and dealerships.

**INVOICE TERMS**

Standard terms are NET 30 days. Finance charges of 1-1/2% will be added to delinquent accounts after 45 Days and for each 30 Days thereafter until paid.

Complaints involving newly received merchandise must be reported within 10 days from receipt to qualify for full invoice remittance suspension or term extension. Otherwise only items in dispute can be suspended from payment of invoice within terms.

**WAREHOUSE/STORAGE**

DARRAN will determine order warehousing approvals on a case by case basis. Orders that can be accommodated will be limited to a max of 30 days storage and must be invoiced at time of storage. Orders that exceed factory storage capacity will be transferred to local storage facilities subject to current storage rates and handling-transit charges. Storage charges must be paid prior to order release to shipping.

**EXECUTIVE OFFICE & CONFERENCE ROOM  
FURNITURE**

**November 3, 2015 through November 2, 2020**

FSC Group 71

GSA CONTRACT NUMBER: GS-27F-001DA

Business Classification:

WBENC Certified Woman-Owned Small Business

DARRAN FURNITURE INDUSTRIES

2402 SHORE DRIVE

HIGH POINT, NC 27263

336.861.2400 FAX 336.861.6485

Business Classification:

Woman-Owned Small Business

On-line access to contract ordering information, terms and conditions, up-to-date pricing, and the option to create an electronic delivery order are available through GSA Advantage!, a menu driven database system. The INTERNET address for GSA Advantage is <http://www.fss.gsa.gov>

For more information on ordering from Federal Supply Schedules click on the FSS Schedules button at <http://www.fss.gsa.gov>

**1a. Special Item Number**

711-8: Executive Office Furniture

711-9: Executive Conference Room Furniture

711-11: Tables and Accessories

711-16: Upholstered Seating

711-18: Multi-purpose Seating

**2. Maximum Order Limitations:**

711-8 \$500,000

711-9 \$500,000

711-11 \$500,000

711-16 \$300,000

711-18 \$200,000

**3. Minimum Order: \$100**

**4. Geographic Coverage:** 48 Contiguous States and the District of Columbia

**5. Point of Production:** High Point, North Carolina (Randolph County)

**6. Discount:** Prices shown herein are List (Discount is 56.9% Off List)

**7. Quantity Discounts:**

• \$467,837 List to \$1,000,000 List = 59.70%

• \$1,000,001 List to \$1,315,789 List = 61.70%

**8. Payment Terms:** ½% - Net 15 Days, Net 30 Days

**8a. Terms and Conditions of Government Credit Card Acceptance:**

a. No discount allowed for payment by Government Purchase Card

b. Provide commercial credit card number

c. Provide commercial credit card expiration date

d. Provide individual's name as it appears on

credit card

e. Provide telephone number of individual to whom credit is issued

**9a. Government Purchase Cards are accepted below the Micro Purchase Threshold.**

**9b. Government Purchase Cards are accepted above the Micro Purchase Threshold.**

**10. Foreign Terms:** None

**11a. Time of Delivery:** Regular Product: 60 - 90 days after receipt of order

Quick Ship Program: Contact DARRAN

**11b. Quick Ship Program:** Items available for expedited delivery are included in main Price Lists.

**11c. Overnight and 2-day delivery:** N/A

**11d. Urgent Requirements:** Will be considered on an individual basis. Contact DARRAN for details.

**12. FOB Point:** All destinations are limited to Commercial docks only. Carriers may refuse non-dock deliveries.

**12a. Freight Prices:**

a. All prices shown are suggested list prices with freight included where indicated.

b. Freight allows delivery to one qualified destination.

c. Within the Continental USA, all orders above \$1,500 net are shipped FOB factory, freight prepaid and allowed. All orders less than \$1,500 net will be subject to a \$100 net freight charge.

**13. Ordering Address:**

DARRAN Furniture Industries

P.O. Box 7614

High Point, NC 27264

Ph: 800.334.7891

Fax: 336.861.6485

**13a. Payment Address:**

BB&T

P.O. Box 890011

Charlotte, NC 28289-0011

**14. Warranty Provision:** Limited Lifetime (Contact DARRAN for details)

**15. Export Packing Charges:** Quoted on request

**13. Terms and Conditions: Order Cancellation / Changes.**

Restocking/Returns: No merchandise may be returned without a return authorization and shipping instructions. No credit or allowance will be given for repairs to defective materials unless DARRAN has given authority to make such repairs. A restocking charge of 25% will apply.

Cancellation: No cost prior to production. After

## GSA CUSTOMER INFORMATION

production has begun, only actual cost incurred will be billed to the Government that cannot be recovered through resale in 6 months

**14. Terms and Condition of Rental, Maintenance and Repair: Consult the Factory.**

**15. Terms and Conditions of Installation:** Installation by a Third party to be quoted on a per job basis. The ordering must specify what ranges of installation services are required.

**16. Terms and Conditions of Repair Parts:** Contact DARRAN for details.

**17. List of Service and distribution points:** Contact DARRAN for details..

**18. Preventative Maintenance:** Information enclosed with product.

**19. List of Participating Dealers:** Contact DARRAN for details.

**23. Environmental Attributes:** DARRAN is compliant with EPA standards. All plywood core material is CARB 2 compliant and contains recycled content. All DARRAN Casegood Products are BIFMA Level 2 Certified. DARRAN is FSC CoC Certified and our products are MAS Certified for Indoor Air Quality.

**23a. Recyclable and Recycled Content Packaging:** The corrugated packaging that is supplied to DARRAN, meets the federal mandate that requires the paperboard to be composed of 30%-50% recycled paper, and in some cases the recycled content is close to 100%.

**23b. Chemical Emission:** DARRAN finishes its products in an ENVI-CT Finish. (Environmental Coatings Technology). DARRAN's seating is finished with a low VOC Conversion Varnish and the casegoods are finished with a formaldehyde free, low VOC Urethane finish. These ENVI-CT finishes allow DARRAN's products to be MAS Certified Green under the ANSI BIFMA X7.1 Standard. Products assist with LEED 4.5 Credit.

**23c. Vapor Emissions:** DARRAN's ENVI-CT finishes use the latest environmental coatings technology to provide lasting durability and exceptional clarity with BACGUARD Silver anti-microbial protection built-in. The ENVI-CT finishes allows DARRAN casegoods to be MAS Certified Green meeting LEED Credit 4.5.

**24a. Duns Number:** 08-363-5318

**24b. Cage Code:** 0Y-6B6

**24c. Federal ID Number:** 56-117-1971

**24d. NAICS Code:** 337211

**25. SAM Network:** DARRAN is registered

## SHIPPING SCHEDULE

When requested, DARRAN will assist in locating special express carriers that may have short transit times. These services may exceed our prepaid freight costs; therefore, pricing is limited to the Freight Excluded formula with special express charges added to the invoice.

For special deliveries, DARRAN will make every effort to meet the appointed time; however DARRAN will not be responsible for any additional charges for late deliveries beyond our control.

## PRICES

- › All prices shown are suggested list prices with freight included where indicated.
- › Freight allows delivery to one qualified destination.
- › Within the Continental USA, all orders above \$1,500 net are shipped FOB factory, freight prepaid and allowed. All orders less than \$1,500 net will be subject to a \$100 net freight charge.

## SPECIAL HANDLING

- Orders requiring special services are subject to an additional charge. These services include:
- › Reconsignment from original destination to new destination - \$35 plus quoted rate to new destination
  - › Refused/Returned Freight: Freight refused at destination and returned to DARRAN - Charge will include freight charges by carrier
  - › Freight refused at time of delivery; returned to DARRAN to deliver at a later date - Charge will include freight charges by carrier
  - › Detention Fees (after 2 hours of waiting) - \$80 net
  - › Weekend delivery available Friday after 3:00 pm through Sunday night or Holiday - \$400 net
  - › Customer Pickup - No charge
  - › Change of Tags/Address/Phone #'s on Shipments - \$35 net

## CALL BEFORE DELIVERY REQUEST

DARRAN will arrange for carriers to call before delivery when requested.

Important Non-Qualified Destinations DARRAN Prepaid Freight Pricing does not include delivery to:

- › Residential Areas
- › Restricted Commercial Areas
- › No Dock Locations
- › Inside delivery/setup service

Orders received and installed without professional Furniture Installers voids all Warranty Coverage.

## CARRIER SELECTION

DARRAN selects and uses only carriers specialized in furniture transportation. Customer requested carriers can be authorized using Freight Excluded pricing with invoice add-on.

## SPECIFIC DELIVERY TIMES

DARRAN will assist in coordinating a requested delivery time from a carrier. DARRAN makes no guarantees and accepts no responsibility for such services as DARRAN has no control over possible carrier hazards. To ensure specific time arrival, we recommend arranging single stop, designated load carriers. Less than trailer load (LTL) shipments cannot be coordinated for a guaranteed delivery time.

## EXPRESS CARRIERS

When requested DARRAN will assist in locating special express carriers that may have short transit times. These services exceed our prepaid freight cost, therefore, pricing is limited to the Freight Excluded formula with special express charges added to invoice.

## FEATURES & ADVANTAGES

### VENEER AND HPL TOPS

Wood veneer tops and high-pressure laminate tops feature a M2 Grade, CARB2 MDF Core with balanced 3-ply construction. Tops are 1-5/16" thick on all veneer and HPL products except for the Rift Collection, which features 1-1/2" thick primary work surfaces. Tops are connected to chassis with steel angle brackets, wood cleats and dowels. DARRAN only uses HPVA A Grade Flat Cut Cherry, Maple, and Walnut Veneers that are book-matched and slip-matched. Rift-Cut White Oak and Quarter-Cut Ash are available as premium veneers. DARRAN's Rift Collection features a double-cut veneer in a rift-cut pattern for a clean linear aesthetic. Veneer tops feature shapeable MDF edges, 3/4", 1", or 3mm external solid hardwood bands based on collection and edge selection. HPL tops feature a laminate self edge, shapeable MDF edge, or a 3mm solid wood edge based on edge selection.

### CHASSIS & PEDESTAL CONSTRUCTION

All pedestals and chassis are constructed with 3/4" thick balanced 3-ply panels. Panels are securely fastened together using rails that are bored and doweled, glued, metal reinforcement brackets and wood cleat construction. Thick end panels are pre-bored to accept a tee nut for the adjustable glide and are reinforced with pvc banding to prevent glide tear out. Glue blocks are used where 3/4" thick panels are joined, bored for tee nut to accept adjustable glide.

### OVERHEAD CABINET CONSTRUCTION

(FREESTANDING AND WALL MOUNT)

Freestanding Overhead storage cabinets are constructed of 1" and 3/4" thick balanced 3-ply panels. Panels are attached with cam fasteners in conjunction with dowels securely adhered with PVAc (white polyvinyl acetate) glue. All surface mount cabinets connect to work surface with anti-slip tape. Wall mount cabinets are mounted to the wall with steel "z" bracket attachment method using 5mm euro screws to attach to the back of the cabinet. All units ship with a steel "z" bracket. This bracket is mounted to the wall by field installers. Installers are responsible for selecting and supplying appropriate fasteners for wall conditions.

### BOOKCASE CONSTRUCTION

All chassis (sides, back, top and bottom panels) are constructed with 3/4" thick balanced 3-ply panels. Panels are attached with cam fasteners in conjunction with dowels securely adhered with PVAc (white polyvinyl acetate) glue. Shelves on all units are 3/4" thick balance 3 ply panels. Optional heavy duty shelves are 1" thick lumber core balanced 5 ply construction.

### TACKBOARDS

Wall mount tackboards are constructed of .75" thick fiberboard. The fabric is precisely aligned and fitted to the tackboard with a sock on cover.

Overhead storage tackboards are constructed of .5" thick fiberboard. The fabric is precisely aligned and fitted to the tackboard and adhered to the rigid hardboard with staples.

### ADJUSTABLE GLIDES

Glides provide 1" of vertical leveling adjustment. Glide bottom is durable metal.

### DRAWERS

All drawers are constructed of four sides and a bottom, which are attached to a drawer front with screws for easy removal. Drawer fronts feature vertically matched veneer within each pedestal. Pencil trays are standard in all box drawers. Jamestown, Prado, Rift, and Spaces feature maple veneer 1/2" thick material for drawer sides, fronts and backs with a UV finish for maximum durability. Drawer bottoms are 7/32" thick 3-ply maple veneer. Drawer boxes are assemble at each corner with dowel joinery for maximum drawer strength. Capitol Park, Central Park, NSsq, Reception Park, and Richmond Park feature drawers that are 1/2" thick wood grained wrapped 5 sided miter-folded construction with 1/8" thick hardboard bottoms.

### SUSPENSIONS

All casegoods utilize cold rolled steel zinc plated high-grade drawer suspensions. All suspensions are warranted for the lifetime of the product. Box and File drawers are full extension, featuring steel ball bearings for a smoother quieter range of motion with soft close operation and are rated 100lbs. Lateral file drawers are a progressive action full extension suspension with the soft close operation and is rated at 150lbs. Lateral files include anti tip mechanism that will allow only one drawer at a time to be opened.

### HINGES

Units with doors include 95 degree swing hinges.

### FILING

Capitol Park, Central Park, NSsq, Reception Park, and Richmond Park feature a highly durable black plastic extrusion that is securely fastened into a route on top of the drawer. Desk drawers are provided with a cross bar that allows for adjustability for letter or legal filing side to side, letter width filing front to back without the use of a cross bar. Credenza and Return filing is letter width front to back and legal width side to side without the use of a cross bar, letter width side to side with the use of a cross bar. Lateral files feature legal with filing side to side and two rows of letter width front to back with the use of cross bars.

Jamestown, Prado, Rift, and Spaces feature metal file frames around the perimeter of the drawers with cross bars. Desk drawers are provided with a cross bar that allows for adjustability for letter or legal filing side to side, letter width filing front to back without the use of a cross bar. . Legal width drawers are specified on desks 72" and larger, and filing is legal front to back or two rows letter side to side. Credenza and Return filing is letter width front to back and legal width side to side without the use of a cross bar, letter width side to side with the use of a cross bar. Lateral files feature legal with filing side to side and two rows of letter width front to back with the use of cross bars.

### LOCKS

Silver, black or bronze face locks are standard on all desks, credenzas, returns, and modular pedestals and match the color of the pull selection. Locks are optional on door storage,

overhead storage, towers with doors and all door units. Each drawer pedestal is independently locked. Lock plugs are factory or field installed.

**KEYING**

Keying is available either factory or field installed. Factory installed keying is random.

**WIRE MANAGEMENT**

Wire management capabilities include standard and optional worksurface grommets. When grommets are standard or specified in a unit, wire channels under the surface are provided for organization and management of all communication wires and cords.

**GROMMETS**

Metal grommets are provided to match the drawer pull selection. Grommet is available in black, silver or white. Must specify standard or non-standard location. Black plastic grommets are available as an option for vertical applications.

**ALUMINUM FRAME DOORS**

Extruded aluminum mitered frame is clear anodized silver aluminum. Frame is 7/8" thick and 1 3/4" high with an 8mm (5/16") visible frame. Frosted glass is standard and white glass is available as an option. Glass I inset within the frame.

**POWERPORTS**

A large selection of powerports are available and handle power, data, docking stations and communication. See options section for selection.

**LED TASKLIGHTS**

LED task lighting provides high efficiency, low energy lighting with long life. LED lights are encased in a silver aluminum alloy material with built in switch to turn the light on/off. Lights are factory installed.

*Product specifications listed below:*

- Diffuser creates a softer light and eliminates hot spots.
- Built in switch with dimmer control.
- 30w 12Vdc 120V (UL approved) power supply
- Can be "daisy chained" up to 30W
- 50,000 hour life

SIZE	VOLTAGE	WATTAGE	COLOR TEMP.	CRI
24" light	12Vdc	6.4	5000K	90
48" light	12Vdc	12.8	5000K	90
60" light	12Vdc	16	5000K	90

**FINISHES**

**"W" VENEER**  
Veneer

**"G" LAMINATE HPL TOPS**  
HPL

**"M" THERMALLY FUSED LAMINATE**  
TFL

WAC Amber Cherry .....	GAC Amber Cherry .....	N/A
WRC Caramel Cherry.....	N/A	
WIC Crimson Cherry .....	GIC Crimson Cherry	
WEC Ebony Cherry .....	N/A	
WHC Honey Cherry.....	GHC Honey Cherry	
WOC Koko Cherry.....	GOC Koko Cherry	
WSC Scotch Cherry .....	N/A	
WAM Alabaster Maple .....	GAM Alabaster Maple	
WCM Clear Maple .....	GCM Clear Maple	
WWM Wheat Maple.....	GWM Wheat Maple	
WBO Blush Oak .....	N/A	
WMO Mocha Oak.....	N/A	
WTO Toast Oak.....	N/A	
WVO Wheat Oak.....	N/A	
WEW Executive Walnut.....	GEW Executive Walnut	
WRW Gray Luster Walnut .....	GRW Gray Luster Walnut	
WGW Gunstock Walnut.....	GGW Gunstock Walnut	
WJW Judicial Walnut.....	N/A	
WNW Natural Walnut.....	GNW Natural Walnut	
WTW Studio Teak Walnut.....	GTW Studio Teak Walnut	
WWP Full Fill Designer White .....	GWL Designer White	

Send 3x3 or larger finish chip for color match. Custom finish upcharge is 3% or \$250 Net (whichever is greater).

**FINISH**

ENVI-CT Green Certified European Technology Coatings Finish with Anti-microbial protection.

**VENEER AND HPL TOPS**

Wood veneer tops and high-pressure laminate tops feature a M2 Grade, CARB2 MDF Core with balanced 3-ply construction. Tops are 1-5/16" thick on all veneer and HPL products except for the Rift Collection, which features 1-1/2" thick primary worksurfaces. Tops are connected to chassis with steel angle brackets, wood cleats and dowels. DARRAN only uses HPVA A Grade Flat Cut Cherry, Maple, and Walnut Veneers that are book-matched and slip-matched. Rift-Cut White Oak and Quarter-Cut Ash are available as premium veneers. DARRAN's Rift Collection features a double-cut veneer in a rift-cut pattern for a clean linear aesthetic. Veneer tops feature shapeable MDF edges, 3/4", 1", or 3mm external solid hardwood bands based on collection and edge selection. HPL tops feature a laminate self edge, shapeable MDF edge, or a 3mm solid wood edge based on edge selection.

**CHASSIS**

3/4" thick core, Medium Density Fiberboard (MDF) rated EPP/SCS/CARB-II material with 3 ply balanced construction. Pedestal and cabinets feature dowel construction reinforced with steel bracket plates, wood cleats, screws and glue. Exposed interiors feature finished veneer of same species as exterior faces. Panel molding standard on approach and end panels of all worksurface height units.

NOTE: All units are standard with 1" adjustable glides that allow for leveling of units.

**DRAWER FRONTS**

Drawer fronts are vertically matched in balanced sets. Doors feature vertical veneer bookmatched horizontally in sets of 2 / 4 and 6 doors. All drawers and doors have traditional scallop profile edge shape. All tower fronts matched in vertical sets.

**STANDARD WOOD DRAWERS**

Optional hardwood veneer plywood drawers feature banded top and bottom edges for smoothness. Drawers are dowel joint construction with a UV cured finish over maple veneers, plus a lifetime free replacement guarantee.

**RANDOM LOCKS & KEYING (STANDARD)**

Locks are standard on all storage units below the worksurface. Random lock cores are installed at the factory. Some units may be shipped with the same key number. Locks are Silver, Black or Bronze and match pull finish unless specified.

- SRK: Random Silver Random Key - n/c
- BRK: Random Black Random Key - n/c
- ZRK: Random Bronze Random Key - n/c

**FIELD INSTALLED LOCKS & KEYING (OPTION)**

Field installed lock option can be selected, each unit is shipped with an empty lock cylinder. A separate line item must be ordered to receive the numbered lock cores for field installation. Field installed locks are available at no additional charge. Specify Silver or Black Locks.

- SFK: Field Installed Silver Random Key - n/c
- BFK: Field Installed Black Random Key - n/c
- ZFK: Field Installed Bronze Random Key - n/c

**STANDARD PROFILE**

Undercut Bevel  
Hardwood Rim Band Species Same As Surface Veneer

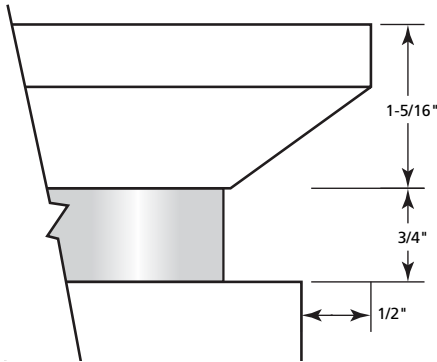

**CHASSIS/BASE PROFILE**

A 35mm x 35mm x 63mm extruded Aluminum Anodized leg provides a floating appearance that reduces damages from footwear and floor maintenance. The leg is recessed 3/4" under the cabinet.

Delete legs and extend front to floor at no additional upcharge.

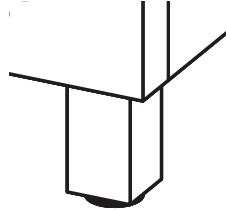

**HOOKUP EDGE PROFILE**

Bridge and Returns have reverse profiles for flush surfaces. Anodized subtop spacer continued uninterrupted across hookup end.

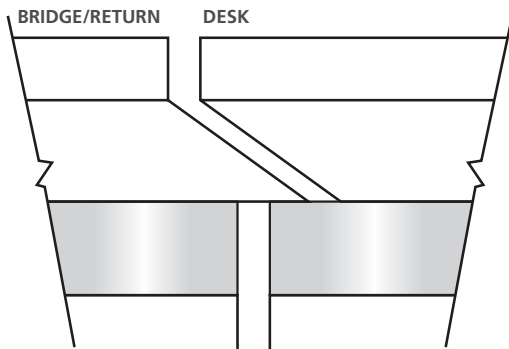

**PULLS**

Factory Installed

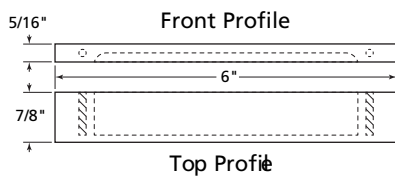

PL-210 Anodized Aluminum

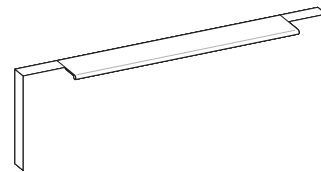
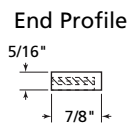

PL-250 Aluminum

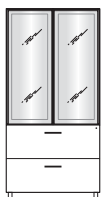

**ALUMINUM FRAME DOORS**

Open with touch latch assist - without pulls

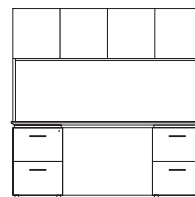

**OVERHEAD DOORS**

Open with door bottom overhang. Pulls available on request

**OPTIONAL GROMMETS**

Factory Installed

Grommets (Standard Location)

Specify Color and Left/Right/Center - \$45 ea.

- Black: TM30-R (Right), TM30-L (Left), TM30-C (Center)
- Silver: TM31-R (Right), TM31-L (Left), TM31-C (Center)
- Antique Brass: TM33-R (Right), TM33-L (Left), TM33-C (Center)

Grommets (Non-Standard Location)

Provide drawing w/ Grommet Location and Specify Color - \$90 ea.

- Black: TM30-NS
- Silver: TM31-NS
- Antique Brass: TM33-NS

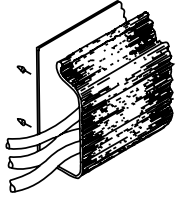

Horizontal J-Channel wire management (Sku: W-1) is sold separately to conceal wire under worksurfaces.

W1



TM30  
Black  
1-5/8" Dia.



TM31  
Silver  
1-5/8" Dia.

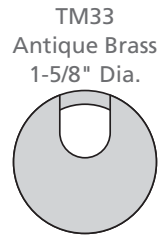

TM33  
Antique Brass  
1-5/8" Dia.



TM50  
Black  
1-5/8" Dia.

**GROMMETS (VERTICAL SURFACE)**

Standard Location - \$45 ea.

- Black Plastic Vertical Surface: TM50-C (Bottom Center)

Non-Standard Location - \$90 ea.

- Black Plastic Vertical Surface: TM50-NS

**STANDARD GROMMET LOCATION REFERENCE**

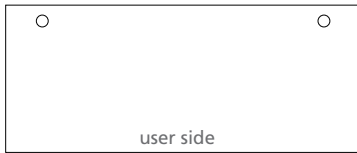

Desk  
Specify Right or Left Grommet



6" Overhang Desk  
Specify Right or Left Grommet

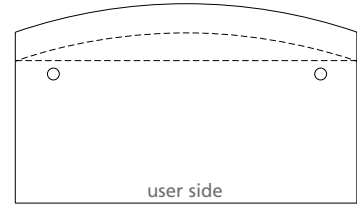

6"/12" Bow Front Desk  
Specify Right or Left Grommet



Bullet Conference Desk (Right Post)  
Center Grommet

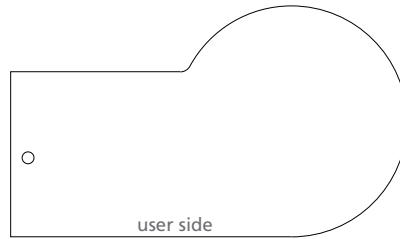

P Conference Desk (Right Post)  
Center Grommet

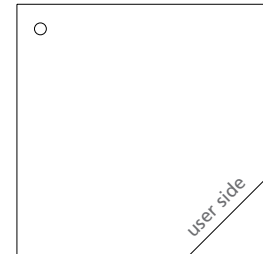

Corner  
Center Grommet



Bridge  
Center Grommet

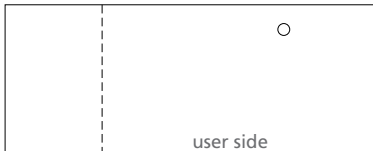

Return (Left Pedestal Shown)  
Right Pedestal - Left Grommet  
Left Pedestal - Right Grommet



**GANGING – FLUSH CUT MODIFICATION**

30”H Casegood Worksurface & Base Ganging Modifications

To gang two casegood units, each unit end to be ganged must be flush cut modified for gapless surfaces and cabinet chassis.

Order Option:

- FC-B: Flush Unit Both Sides(Facing) for Ganging - \$95
- FC-L: Flush Unit Left (Facing) for Ganging - \$95
- FC-R: Flush Unit Right (Facing) for Ganging - \$95

Flush cut modification per unit includes all modifications to gang to one end or both ends when units are ganged. Modification includes tops, base and molding. Modification reduces width size approximately 1” per end.

Overhead consoles and towers are offered freestanding and ganging – inclusive of flush cut modifications.

Example:

SPC9424CA052W Two Drawer Lateral File (Left) Flush Cut Right – FC-R...\$95

SPC7124CA054W Kneespace Credenza (Right) Flush Cut Left – FC-L...\$95

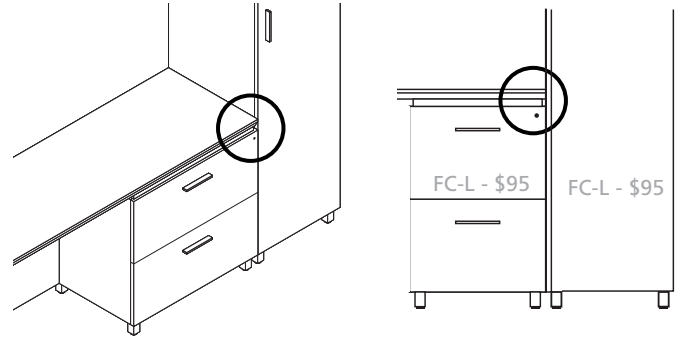

**HEIGHT REFERENCE**

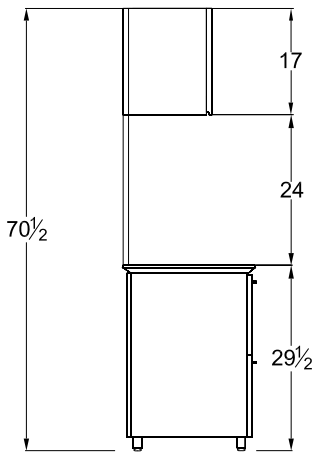

Typical Single Height Side Profile Wall Hung Overhead

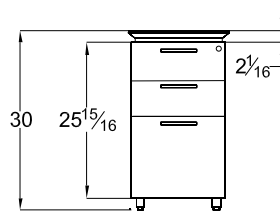

Pedestal Front Profile Box/Box/File

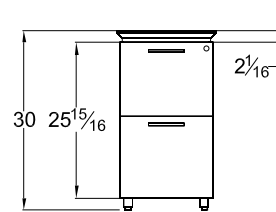

Pedestal Front Profile File/File

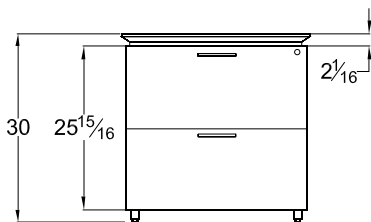

Pedestal Front Profile Lateral File

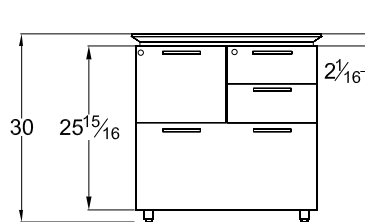

Pedestal Front Profile Multi-File

MODESTY REFERENCE

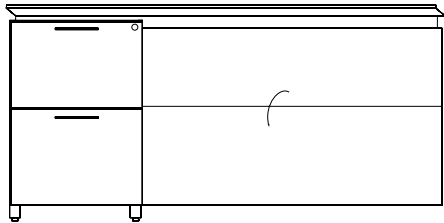

**M34**  
Drop Door Tech Modesty

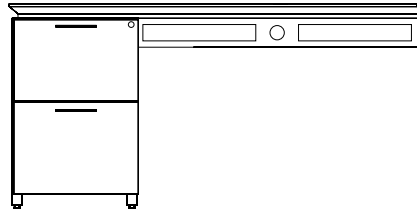

**M51**  
Open Back Modesty with 4" Wire Management Rail

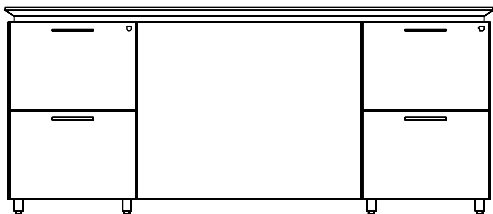

**M37**  
Fixed Full Modesty

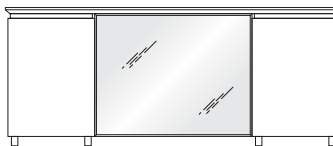

**M-40FG (OPTION)**  
Mini-Frame Frosted Glass Modesty

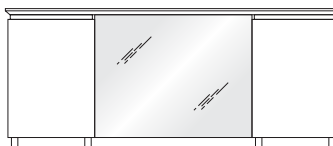

**M-40WG (OPTION)**  
Mini-Frame White Glass Modesty

WOOD PANEL DOORS

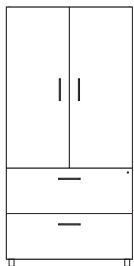

ALUMINUM MINI-FRAME WITH FROSTED PANEL

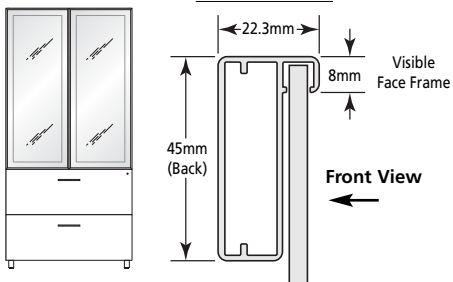

OPTIONAL: ALUMINUM ACCENT FRAME WITH WHITE GLASS

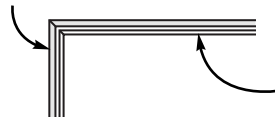
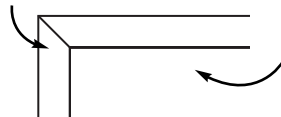
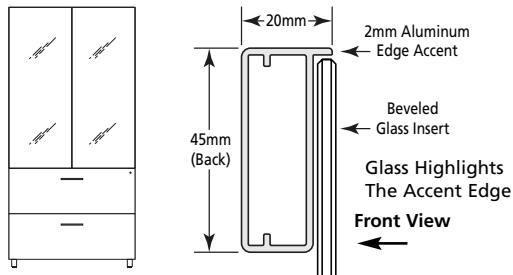

GRAIN DIRECTION

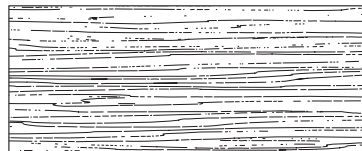

Desk

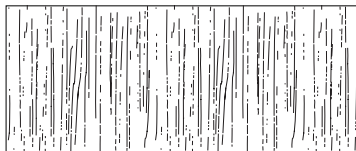

Runoff Desk

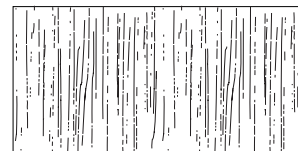

Bridge



Credenza

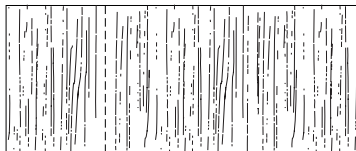

Return

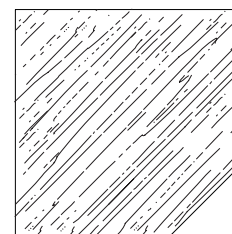

Corner

**INTERIOR DRAWER DIMENSIONS**

UNIT DEPTH	DRAWER TYPE	OVERALL DIMENSIONS			INTERIOR DRAWER DIMENSIONS			NOTES
		W	D	H	W	D	H	
15-5/8" Letter	30" Box	13-1/8	19-11/16	4	12-1/8	18-11/16	3-7/16	Units less than 72"
	30" File	13-1/8	19-11/16	9-13/16	12-1/8	18-11/16	9-5/16	Units less than 72"
	24" Box	13-1/8	16-1/16	4	12-1/8	15-1/16	3-7/16	Units less than 72"
	24" File	13-1/8	16-1/16	9-13/16	12-1/8	15-1/16	9-5/16	Units less than 72"
18-9/16" Legal	36" Box	16-1/6	19-11/16	4	12-1/8	18-11/16	3-7/16	Units 72" & above
	36" File	16-1/6	19-11/16	9-13/16	12-1/8	18-11/16	9-5/16	Units 72" & above
	30" Box	16-1/6	19-11/16	4	12-1/8	18-11/16	3-7/16	Units 72" & above
	30" File	16-1/6	19-11/16	9-13/16	12-1/8	18-11/16	9-5/16	Units 72" & above
	24" Box	16-1/6	16-1/16	4	12-1/8	15-1/16	3-7/16	Units less than 72"
	24" File	16-1/6	16-1/16	9-13/16	12-1/8	15-1/16	9-5/16	Units less than 72"
29" Lateral	24" File	26-1/2	16-1/16	9-13/16	25-1/2	15-1/16	9-5/16	Workstation Credenzas less than 82"
31" Lateral	24" File	28-9/16	16-1/16	9-13/16	27-9/16	15-1/16	9-5/16	Multi-File Lateral File
35" Lateral	24" File	32-1/2	16-1/16	9-13/16	31-1/2	15-1/16	9-5/16	Workstation Credenzas over 83"

**FILING REFERENCE**

**FILING FOR 24" DEPTH UNITS**

13" Wide File Drawer - 16" Deep

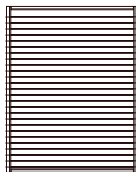

Letter Front to Back

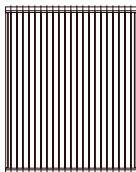

Legal Side to Side with File Rail

**FILING FOR 30" & 36" DEPTH UNITS**

13" Wide File Drawer - 20" Deep

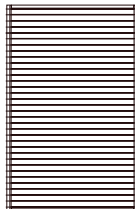

Letter Front to Back

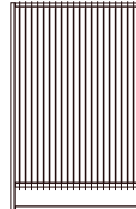

Legal Side to Side with File Rail

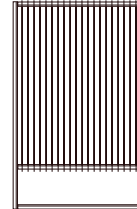

Letter Side to Side with File Rail

**29" LATERAL FILE DRAWER**

26-1/2" Wide File Drawer - 16-1/16" Deep

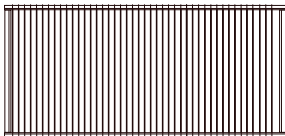

Legal Side to Side

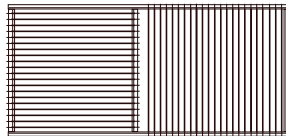

Legal Side to Side Letter Front to Back with File Rail

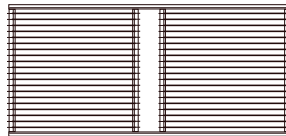

Letter Front to Back with File Rail

**35" LATERAL FILE DRAWER**

32-1/2" Wide File Drawer - 16-1/16" Deep

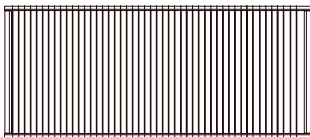

Legal Side to Side

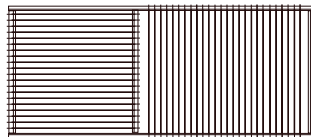

Legal Side to Side Letter Front to Back with File Rail

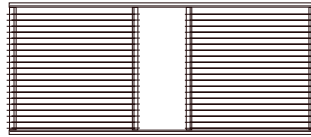

Letter Front to Back with File Rail

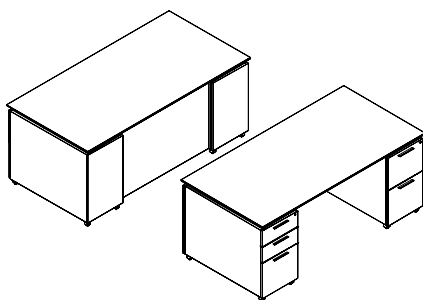

**EXECUTIVE / BREAKFRONT**

**STANDARD FEATURES**

- 2" Recessed modesty
- Anodized aluminum feet
- Box/Box/File (left)
- File/File (right)
- Full extension drawers - locking
- Soft close suspension drawer(s)

**NOTES**

- Legal Filing Width: 84" - 72" units
- Letter Filing Width: 66" units

[CLICK HERE TO VIEW PRODUCT INDEX](#)

**1 SELECT A STYLE**

DIMENSIONS		STYLE NUMBER	LIST PRICE	STYLE NUMBER	LIST PRICE	STYLE NUMBER	LIST PRICE
W" x D" x H"	WGT	"W" Veneer Veneer Top Veneer Chassis		"G" HPL High Pressure Laminate Top Veneer Chassis		"M" TFL Thermally Fused Laminate Top Thermally Fused Laminate Chassis	
84 x 36 x 30	360	SPC8436DD000W	4603	SPC8436DD000G	4603	"M" Option N/A	
72 x 36 x 30	325	SPC7236DD000W	4095	SPC7236DD000G	4095	"M" Option N/A	
72 x 30 x 30	300	SPC7230DD000W	3981	SPC7230DD000G	3981	"M" Option N/A	
66 x 30 x 30	295	SPC6630DD000W	3924	SPC6630DD000G	3924	"M" Option N/A	

**2 SELECT A FINISH**

"W" Veneer	"G" HPL	"M" TFL	
WAC	GAC	-	Amber Cherry
WRC	-	-	Caramel Cherry
WIC	GIC	-	Crimson Cherry
WEC	-	-	Ebony Cherry
WHC	GHC	-	Honey Cherry
WOC	GOC	-	KoKo Cherry
WSC	-	-	Scotch Cherry
WAM	GAM	-	Alabaster Maple
WCM	GCM	-	Clear Maple
WWM	GWM	-	Wheat Maple
WBO	-	-	Blush Oak
WMO	-	-	Mocha Oak
WTO	-	-	Toast Oak
WWO	-	-	Wheat Oak
WEW	GEW	-	Executive Walnut
WRW	GRW	-	Gray Luster Walnut
WGW	-	-	Gunstock Walnut
WJW	-	-	Judicial Walnut
WNW	GNW	-	Natural Walnut
WTW	GTW	-	Studio Teak Walnut
WWP	GWL	-	Designer White

**3 SELECT AN EDGE**



**4 SELECT HARDWARE**

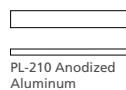

**5 OPTIONS**

**ACCESSORIES**

- K1: Center Drawer - \$275
- K28: Articulating Keyboard w/ Mouse - \$375
- PC10A: Desk pedestal wire cavity w/ access door - \$95

**DRAWER**

- P6: Modify Box/Box/File to File/File - \$50 per pedestal

**FEET**

- D8: Delete feet and extend fronts to floor - N/C

**FLUSH FRONT CHASSIS**

- MODCX: Breakfront chassis converted to flush front chassis - N/C

**GROMMETS (STANDARD LOCATION)**

- Specify Color and Location Right/Left - \$45 ea.
- Black: TM30-R (Right), TM30-L (Left)
- Silver: TM31-R (Right), TM31-L (Left)

**GROMMETS (NON-STANDARD LOCATION)**

- Provide drawing w/ Grommet Location and Specify Color - \$90 ea.
- Black: TM30-NS
- Silver: TM31-NS

**MODESTY**

- Full Modesty:
- M-40FG: Mini-Frame Frosted Glass - \$495
- M-40WG: Mini-Frame White Glass - \$695

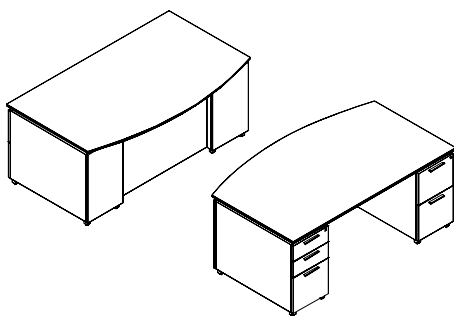

**BOWFRONT / BREAKFRONT**

**STANDARD FEATURES**

- 8" Recessed modesty from edge of top
- Anodized aluminum feet
- Box/Box/File (left)
- File/File (right)
- Full extension drawers
- Soft close suspension drawer(s)

**NOTES**

- Legal Filing Width: 84" - 72" units
- Letter Filing Width: 66" units

[CLICK HERE TO VIEW PRODUCT INDEX](#)

**1 SELECT A STYLE**

DIMENSIONS		STYLE NUMBER	LIST PRICE	STYLE NUMBER	LIST PRICE	STYLE NUMBER	LIST PRICE
W" x D" x H"	WGT	"W" Veneer Top Veneer Chassis		"G" High Pressure Laminate Top HPL Veneer Chassis		"M" Thermally Fused Laminate Top Thermally Fused Laminate Chassis	
84 x 36/42 x 30	375	SPC8442DD006W	5281	SPC8442DD006G	5281	"M" Option N/A	
72 x 36/42 x 30	340	SPC7242DD006W	4772	SPC7242DD006G	4772	"M" Option N/A	
72 x 30/36 x 30	315	SPC7236DD006W	4546	SPC7236DD006G	4546	"M" Option N/A	
66 x 30/36 x 30	305	SPC6636DD006W	4484	SPC6636DD006G	4484	"M" Option N/A	

**2 SELECT A FINISH**

"W" Veneer	"G" HPL	"M" TFL	Finish
WAC	GAC	-	Amber Cherry
WRC	-	-	Caramel Cherry
WIC	GIC	-	Crimson Cherry
WEC	-	-	Ebony Cherry
WHC	GHC	-	Honey Cherry
WOC	GOC	-	KoKo Cherry
WSC	-	-	Scotch Cherry
WAM	GAM	-	Alabaster Maple
WCM	GCM	-	Clear Maple
WWM	GWM	-	Wheat Maple
WBO	-	-	Blush Oak
WMO	-	-	Mocha Oak
WTO	-	-	Toast Oak
WWO	-	-	Wheat Oak
WEW	GEW	-	Executive Walnut
WRW	GRW	-	Gray Luster Walnut
WGW	-	-	Gunstock Walnut
WJW	-	-	Judicial Walnut
WNW	GNW	-	Natural Walnut
WTW	GTW	-	Studio Teak Walnut
WWP	GWL	-	Designer White

**3 SELECT AN EDGE**



Undercut Bevel

**4 SELECT HARDWARE**

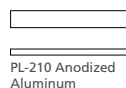

PL-210 Anodized Aluminum



PL-250 Aluminum

**5 OPTIONS**

**ACCESSORIES**

- K1: Center Drawer - \$275
- K28: Articulating Keyboard w/ Mouse - \$375
- PC10A: Desk pedestal wire cavity w/ access door - \$95

**DRAWER**

- P6: Modify Box/Box/File to File/File - \$50 per pedestal

**FEET**

- D8: Delete feet and extend fronts to floor - N/C

**GROMMETS (STANDARD LOCATION)**

Specify Color and Location Right/Left - \$45 ea.

- Black: TM30-R (Right), TM30-L (Left)
- Silver: TM31-R (Right), TM31-L (Left)

**GROMMETS (NON-STANDARD LOCATION)**

Provide drawing w/ Grommet Location and Specify Color - \$90 ea.

- Black: TM30-NS
- Silver: TM31-NS

**MODESTY**

Full Modesty:

- M-40FG: Mini-Frame Frosted Glass - \$495
- M-40WG: Mini-Frame White Glass - \$695

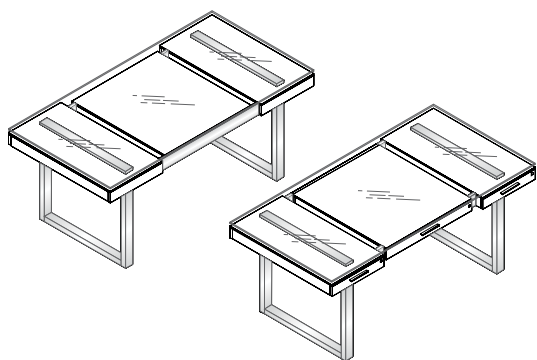

**GLASS TOP W/ METAL SLEIGH BASE**

**STANDARD FEATURES**

- 3 Locking box wood drawers
- Anodized aluminum leg
- Soft close suspension drawer(s)

**NOTES**

- Glass Shipped Separately
- Total Wt. Includes Glass

[CLICK HERE TO VIEW PRODUCT INDEX](#)

**1 SELECT A STYLE**

DIMENSIONS		STYLE NUMBER	LIST PRICE	STYLE NUMBER	LIST PRICE	STYLE NUMBER	LIST PRICE
W" x D" x H"	WGT	<b>"W"</b> Veneer Top Veneer Chassis		<b>"G"</b> High Pressure Laminate Top HPL Veneer Chassis		<b>"M"</b> Thermally Fused Laminate Top TFL Thermally Fused Laminate Chassis	
72 x 36 x 30	335	SPC7236DT096W	5923	"G" Option N/A		"M" Option N/A	

**2 SELECT A FINISH**

<b>"W"</b> Veneer	<b>"G"</b> HPL	<b>"M"</b> TFL	
WAC	-	-	Amber Cherry
WRC	-	-	Caramel Cherry
WIC	-	-	Crimson Cherry
WEC	-	-	Ebony Cherry
WHC	-	-	Honey Cherry
WOC	-	-	KoKo Cherry
WSC	-	-	Scotch Cherry
WAM	-	-	Alabaster Maple
WCM	-	-	Clear Maple
WWM	-	-	Wheat Maple
WBO	-	-	Blush Oak
WMO	-	-	Mocha Oak
WTO	-	-	Toast Oak
WWO	-	-	Wheat Oak
WEW	-	-	Executive Walnut
WRW	GRW	-	Gray Luster Walnut
GWG	-	-	Gunstock Walnut
WJW	-	-	Judicial Walnut
WNW	-	-	Natural Walnut
WTW	-	-	Studio Teak Walnut
WWP	-	-	Designer White

**3 SELECT AN EDGE**

Edge Profile  
Option Not Available

**5 OPTIONS**

**MODESTY**  
- M55W: Optional wood modesty rails replaces anodized aluminum rails - \$195

**4 SELECT HARDWARE**

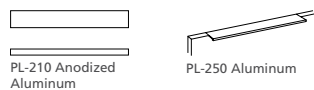

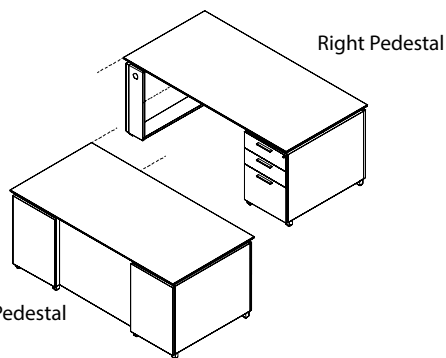

**BREAKFRONT - SINGLE PEDESTAL**

**STANDARD FEATURES**

- 2" Recessed modesty
- Anodized aluminum feet
- Box/Box/File
- Full extension drawers - locking
- Hookup hardware
- Soft close suspension drawer(s)

- If using as freestanding, grommet hole will be visible on end

**NOTES**

- Legal Filing Width: 84" - 72" units
- Letter Filing Width: 66" units

[CLICK HERE TO VIEW PRODUCT INDEX](#)

**1 SELECT A STYLE**

DIMENSIONS		STYLE NUMBER	LIST PRICE	STYLE NUMBER	LIST PRICE	STYLE NUMBER	LIST PRICE
W" x D" x H"	WGT	"W" Veneer Top Veneer Chassis		"G" High Pressure Laminate Top Veneer Chassis		"M" Thermally Fused Laminate Top Thermally Fused Laminate Chassis	
<b>Right Pedestal (Left Hookup)</b>							
84 x 36 x 30	300	SPC8436DS010W	4038	SPC8436DS010G	4038	"M" Option N/A	
72 x 36 x 30	270	SPC7236DS010W	3586	SPC7236DS010G	3586	"M" Option N/A	
72 x 30 x 30	240	SPC7230DS010W	3478	SPC7230DS010G	3478	"M" Option N/A	
66 x 30 x 30	220	SPC6630DS010W	3354	SPC6630DS010G	3354	"M" Option N/A	
<b>Left Pedestal (Right Hookup)</b>							
84 x 36 x 30	300	SPC8436DS009W	4038	SPC8436DS009G	4038	"M" Option N/A	
72 x 36 x 30	270	SPC7236DS009W	3586	SPC7236DS009G	3586	"M" Option N/A	
72 x 30 x 30	240	SPC7230DS009W	3478	SPC7230DS009G	3478	"M" Option N/A	
66 x 30 x 30	220	SPC6630DS009W	3354	SPC6630DS009G	3354	"M" Option N/A	

**2 SELECT A FINISH**

"W" Veneer	"G" HPL	"M" TFL	
WAC	GAC	-	Amber Cherry
WRC	-	-	Caramel Cherry
WIC	GIC	-	Crimson Cherry
WEC	-	-	Ebony Cherry
WHC	GHC	-	Honey Cherry
WOC	GOC	-	KoKo Cherry
WSC	-	-	Scotch Cherry
WAM	GAM	-	Alabaster Maple
WCM	GCM	-	Clear Maple
WWM	GWM	-	Wheat Maple
WBO	-	-	Blush Oak
WMO	-	-	Mocha Oak
WTO	-	-	Toast Oak
WWO	-	-	Wheat Oak
WEW	GEW	-	Executive Walnut
WRW	GRW	-	Gray Luster Walnut
WGW	-	-	Gunstock Walnut
WJW	-	-	Judicial Walnut
WNW	GNW	-	Natural Walnut
WTW	GTW	-	Studio Teak Walnut
WWP	GWL	-	Designer White

**3 SELECT AN EDGE**



**4 SELECT HARDWARE**

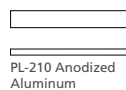

**5 OPTIONS**

**ACCESSORIES**

- K1: Center Drawer - \$275
- K28: Articulating Keyboard w/ Mouse - \$375
- PC10A: Desk pedestal wire cavity w/ access door - \$95

**DRAWER**

- P6: Modify Box/Box/File to File/File - \$50 per pedestal

**FEET**

- D8: Delete feet and extend fronts to floor - N/C

**FLUSH FRONT CHASSIS**

- MODCX: Breakfront chassis converted to flush front chassis - N/C

**GROMMETS (STANDARD LOCATION)**

- Specify Color and Location Right/Left - \$45 ea.
- Black: TM30-R (Right), TM30-L (Left)
- Silver: TM31-R (Right), TM31-L (Left)

**GROMMETS (NON-STANDARD LOCATION)**

- Provide drawing w/ Grommet Location and Specify Color - \$90 ea.
- Black: TM30-NS
- Silver: TM31-NS

**MODESTY**

- Full Modesty:
- M-40FG: Mini-Frame Frosted Glass - \$495
- M-40WG: Mini-Frame White Glass - \$695

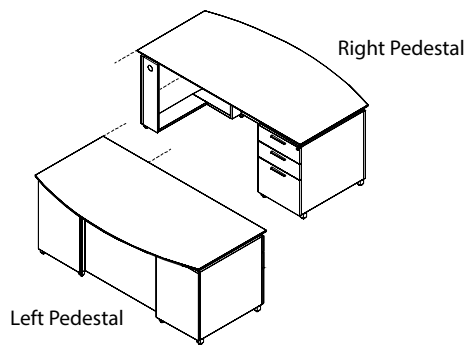

**BOWFRONT BREAKFRONT - SINGLE PEDESTAL**

**STANDARD FEATURES**

- 8" Recessed modesty from edge of Top
- Anodized aluminum feet
- Box/Box/File
- Full extension drawers - locking
- Hookup hardware
- Soft close suspension drawer(s)

- If using as freestanding, grommet hole will be visible on end

**NOTES**

- Legal Filing Width: 84" - 72" units
- Letter Filing Width: 66" units

[CLICK HERE TO VIEW PRODUCT INDEX](#)

**1 SELECT A STYLE**

DIMENSIONS		STYLE NUMBER	LIST PRICE	STYLE NUMBER	LIST PRICE	STYLE NUMBER	LIST PRICE
W" x D" x H"	WGT	"W" Veneer Veneer Top Veneer Chassis		"G" HPL High Pressure Laminate Top Veneer Chassis		"M" TFL Thermally Fused Laminate Top Thermally Fused Laminate Chassis	
<b>Right Pedestal (Left Hookup)</b>							
84 x 36/42 x 30	310	SPC8442DS018W	4717	SPC8442DS018G	4717	"M" Option N/A	
72 x 36/42 x 30	280	SPC7242DS018W	4265	SPC7242DS018G	4265	"M" Option N/A	
72 x 30/36 x 30	265	SPC7236DS018W	4155	SPC7236DS018G	4155	"M" Option N/A	
66 x 30/36 x 30	240	SPC6636DS018W	4033	SPC6636DS018G	4033	"M" Option N/A	
<b>Left Pedestal (Right Hookup)</b>							
84 x 36/42 x 30	310	SPC8442DS017W	4717	SPC8442DS017G	4717	"M" Option N/A	
72 x 36/42 x 30	280	SPC7242DS017W	4265	SPC7242DS017G	4265	"M" Option N/A	
72 x 30/36 x 30	265	SPC7236DS017W	4155	SPC7236DS017G	4155	"M" Option N/A	
66 x 30/36 x 30	240	SPC6636DS017W	4033	SPC6636DS017G	4033	"M" Option N/A	

**2 SELECT A FINISH**

"W" Veneer	"G" HPL	"M" TFL	
WAC	GAC	-	Amber Cherry
WRC	-	-	Caramel Cherry
WIC	GIC	-	Crimson Cherry
WEC	-	-	Ebony Cherry
WHC	GHC	-	Honey Cherry
WOC	GOC	-	KoKo Cherry
WSC	-	-	Scotch Cherry
WAM	GAM	-	Alabaster Maple
WCM	GCM	-	Clear Maple
WWM	GWM	-	Wheat Maple
WBO	-	-	Blush Oak
WMO	-	-	Mocha Oak
WTO	-	-	Toast Oak
WWO	-	-	Wheat Oak
WEW	GEW	-	Executive Walnut
WRW	GRW	-	Gray Luster Walnut
WGW	-	-	Gunstock Walnut
WJW	-	-	Judicial Walnut
WNW	GNW	-	Natural Walnut
WTW	GTW	-	Studio Teak Walnut
WWP	GWL	-	Designer White

**3 SELECT AN EDGE**



Undercut Bevel

**4 SELECT HARDWARE**

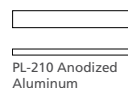

PL-210 Anodized Aluminum



PL-250 Aluminum

**5 OPTIONS**

**ACCESSORIES**

- K1: Center Drawer - \$275
- K28: Articulating Keyboard w/ Mouse - \$375

**DRAWER**

- P6: Modify Box/Box/File to File/File - \$50 per pedestal

**FEET**

- D8: Delete feet and extend fronts to floor - N/C

**GROMMETS (STANDARD LOCATION)**

- Specify Color and Location Right/Left - \$45 ea.
- Black: TM30-R (Right), TM30-L (Left)
- Silver: TM31-R (Right), TM31-L (Left)

**GROMMETS (NON-STANDARD LOCATION)**

- Provide drawing w/ Grommet Location and Specify Color - \$90 ea.
- Black: TM30-NS
- Silver: TM31-NS

**MODESTY**

- Full Modesty:
- M-40FG: Mini-Frame Frosted Glass - \$495
- M-40WG: Mini-Frame White Glass - \$695



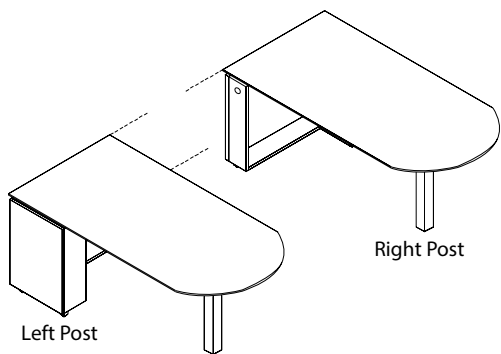

**BULLET**

**STANDARD FEATURES**

- 3" Square anodized aluminum post leg
- False pedestal appearance
- Hookup hardware

**NOTES**

- If using as freestanding, grommet hole will be visible on end.
- "P" Tops and Bullets are not intended to be freestanding

[CLICK HERE TO VIEW PRODUCT INDEX](#)

**1 SELECT A STYLE**

DIMENSIONS		STYLE NUMBER		LIST PRICE	STYLE NUMBER		LIST PRICE	STYLE NUMBER		LIST PRICE
W" x D" x H"	WGT	"W" Veneer	Veneer Top Veneer Chassis		"G" HPL	High Pressure Laminate Top Veneer Chassis		"M" TFL	Thermally Fused Laminate Top Thermally Fused Laminate Chassis	
<b>Right Post Leg (Left Hookup)</b>										
84 x 36 x 30	180	SPC8436DC022W		4038	SPC8436DC022G		4038	"M" Option	N/A	
72 x 36 x 30	170	SPC7236DC022W		3812	SPC7236DC022G		3812	"M" Option	N/A	
72 x 30 x 30	160	SPC7230DC022W		3698	SPC7230DC022G		3698	"M" Option	N/A	
66 x 30 x 30	150	SPC6630DC022W		3642	SPC6630DC022G		3642	"M" Option	N/A	
60 x 30 x 30	140	SPC6030DC022W		3586	SPC6030DC022G		3586	"M" Option	N/A	
<b>Left Post Leg (Right Hookup)</b>										
84 x 36 x 30	180	SPC8436DC023W		4038	SPC8436DC023G		4038	"M" Option	N/A	
72 x 36 x 30	170	SPC7236DC023W		3812	SPC7236DC023G		3812	"M" Option	N/A	
72 x 30 x 30	160	SPC7230DC023W		3698	SPC7230DC023G		3698	"M" Option	N/A	
66 x 30 x 30	150	SPC6630DC023W		3642	SPC6630DC023G		3642	"M" Option	N/A	
60 x 30 x 30	140	SPC6030DC023W		3586	SPC6030DC023G		3586	"M" Option	N/A	

**2 SELECT A FINISH**

"W" Veneer	"G" HPL	"M" TFL	
WAC	GAC	-	Amber Cherry
WRC	-	-	Caramel Cherry
WIC	GIC	-	Crimson Cherry
WEC	-	-	Ebony Cherry
WHC	GHC	-	Honey Cherry
WOC	GOC	-	KoKo Cherry
WSC	-	-	Scotch Cherry
WAM	GAM	-	Alabaster Maple
WCM	GCM	-	Clear Maple
WWM	GWM	-	Wheat Maple
WBO	-	-	Blush Oak
WMO	-	-	Mocha Oak
WTO	-	-	Toast Oak
WWO	-	-	Wheat Oak
WEW	GEW	-	Executive Walnut
WRW	GRW	-	Gray Luster Walnut
WGW	-	-	Gunstock Walnut
WJW	-	-	Judicial Walnut
WNW	GNW	-	Natural Walnut
WTW	GTW	-	Studio Teak Walnut
WWP	GWL	-	Designer White

**3 SELECT AN EDGE**



Undercut Bevel

**4 SELECT HARDWARE**

Hardware Option Not Available

**5 OPTIONS**

- ACCESSORIES**
- K1: Center Drawer - \$275
  - K2: Center Drawer w/ Skirt - \$375
  - K28: Articulating Keyboard w/ Mouse - \$375
  - PC10A: Desk pedestal wire cavity w/ access door - \$95
- FEET**
- D8: Delete feet and extend fronts to floor - N/C
- GROMMETS (STANDARD LOCATION)**
- Specify Color - \$45 ea.
- Black: TM30-C (Center)
  - Silver: TM31-C (Center)
- GROMMETS (NON-STANDARD LOCATION)**
- Provide drawing w/ Grommet Location and Specify Color - \$90 ea.
- Black: TM30-NS
  - Silver: TM31-NS
- MODESTY**
- Full Modesty:
- M-44CW: Curved Wood - \$395
- Half Modesty:
- HM-44CW: Curved Wood - \$295
  - HM-40FG: Mini-Frame Frosted Glass - \$395
  - HM-40WG: Mini-Frame White Glass - \$495

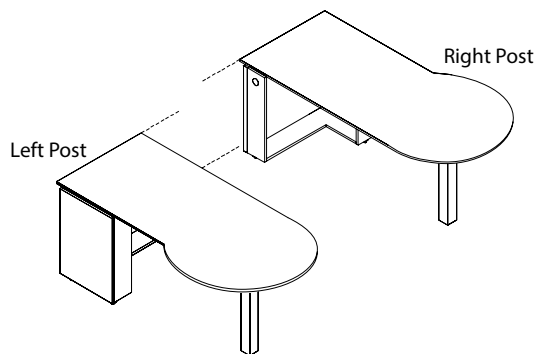

**"P" CONFERENCE DESK**

**STANDARD FEATURES**

- 3" Square anodized aluminum post leg
- False pedestal appearance
- Hookup hardware

**NOTES**

- If using as freestanding, grommet hole will be visible on end.
- "P" Tops and Bullets are not intended to be freestanding

[CLICK HERE TO VIEW PRODUCT INDEX](#)

**1 SELECT A STYLE**

DIMENSIONS		STYLE NUMBER	LIST PRICE	STYLE NUMBER	LIST PRICE	STYLE NUMBER	LIST PRICE
W" x D" x H"	WGT	"W" Veneer Top Veneer Chassis		"G" HPL High Pressure Laminate Top Veneer Chassis		"M" TFL Thermally Fused Laminate Top Thermally Fused Laminate Chassis	
<b>Right Post Leg (Left Hookup)</b>							
84 x 36/42 x 30	200	SPC8442DC027W	4603	SPC8442DC027G	4603	"M" Option N/A	
72 x 36/42 x 30	190	SPC7242DC027W	4377	SPC7242DC027G	4377	"M" Option N/A	
72 x 30/36 x 30	180	SPC7236DC027W	4265	SPC7236DC027G	4265	"M" Option N/A	
66 x 30/36 x 30	170	SPC6636DC027W	4208	SPC6636DC027G	4208	"M" Option N/A	
60 x 30/36 x 30	160	SPC6036DC027W	4151	SPC6036DC027G	4151	"M" Option N/A	
<b>Left Post Leg (Right Hookup)</b>							
84 x 36/42 x 30	200	SPC8442DC028W	4603	SPC8442DC028G	4603	"M" Option N/A	
72 x 36/42 x 30	190	SPC7242DC028W	4377	SPC7242DC028G	4377	"M" Option N/A	
72 x 30/36 x 30	180	SPC7236DC028W	4265	SPC7236DC028G	4265	"M" Option N/A	
66 x 30/36 x 30	170	SPC6636DC028W	4208	SPC6636DC028G	4208	"M" Option N/A	
60 x 30/36 x 30	160	SPC6036DC028W	4151	SPC6036DC028G	4151	"M" Option N/A	

**2 SELECT A FINISH**

"W" Veneer	"G" HPL	"M" TFL	Finish
WAC	GAC	-	Amber Cherry
WRC	-	-	Caramel Cherry
WIC	GIC	-	Crimson Cherry
WEC	-	-	Ebony Cherry
WHC	GHC	-	Honey Cherry
WOC	GOC	-	KoKo Cherry
WSC	-	-	Scotch Cherry
WAM	GAM	-	Alabaster Maple
WCM	GCM	-	Clear Maple
WWM	GWM	-	Wheat Maple
WBO	-	-	Blush Oak
WMO	-	-	Mocha Oak
WTO	-	-	Toast Oak
WWO	-	-	Wheat Oak
WEW	GEW	-	Executive Walnut
WRW	GRW	-	Gray Luster Walnut
WGW	-	-	Gunstock Walnut
WJW	-	-	Judicial Walnut
WNW	GNW	-	Natural Walnut
WTW	GTW	-	Studio Teak Walnut
WWP	GWL	-	Designer White

**3 SELECT AN EDGE**



Undercut Bevel

**4 SELECT HARDWARE**

Hardware Option Not Available

**5 OPTIONS**

**ACCESSORIES**

- K1: Center Drawer - \$275
- K2: Center Drawer w/ Skirt - \$375
- K28: Articulating Keyboard w/ Mouse - \$375
- PC10A: Desk pedestal wire cavity w/ access door - \$95

**FEET**

- D8: Delete feet and extend fronts to floor - N/C

**GROMMETS (STANDARD LOCATION)**

- Specify Color - \$45 ea.
- Black: TM30-C (Center)
- Silver: TM31-C (Center)

**GROMMETS (NON-STANDARD LOCATION)**

- Provide drawing w/ Grommet Location and Specify Color - \$90 ea.
- Black: TM30-NS
- Silver: TM31-NS

**MODESTY**

- Full Modesty:
  - M-44CW: Curved Wood - \$395
- Half Modesty:
  - HM-44CW: Curved Wood - \$295
  - HM-40FG: Mini-Frame Frosted Glass - \$395
  - HM-40WG: Mini-Frame White Glass - \$495
  - HM-44CW: Curved Wood - \$295
  - HM-40FG: Mini-Frame Frosted Glass - \$395
  - HM-40WG: Mini-Frame White Glass - \$495

**WORKSTATION RUNOFF DESKS**

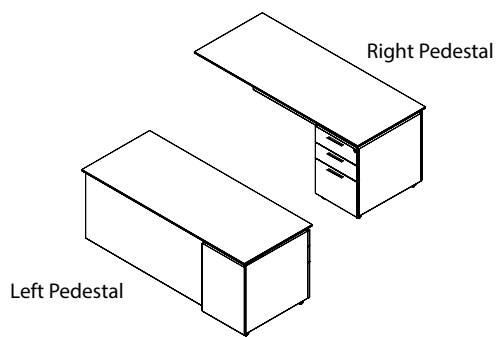

**BREAKFRONT - SINGLE PEDESTAL**

**STANDARD FEATURES**

- 2" Recessed modesty
- Anodized aluminum feet
- Box/Box/File
- Full extension drawers - locking
- Hookup hardware
- Soft close suspension drawer(s)

- For use with workstation credenzas

**NOTES**

- Legal Filing Width: 72" units
- Letter Filing Width: 66" - 54" units

[CLICK HERE TO VIEW PRODUCT INDEX](#)

**1 SELECT A STYLE**

DIMENSIONS		STYLE NUMBER		LIST PRICE	STYLE NUMBER		LIST PRICE	STYLE NUMBER		LIST PRICE
W" x D" x H"	WGT	"W" Veneer	Veneer Top Veneer Chassis		"G" HPL	High Pressure Laminate Top Veneer Chassis		"M" TFL	Thermally Fused Laminate Top Thermally Fused Laminate Chassis	
<b>Right Pedestal (Left Hookup)</b>										
72 x 30 x 30	210	SPC7230DR020W		3072	SPC7230DR020G		3072	"M" Option	N/A	
66 x 30 x 30	190	SPC6630DR020W		2902	SPC6630DR020G		2902	"M" Option	N/A	
60 x 30 x 30	170	SPC6030DR020W		2867	SPC6030DR020G		2867	"M" Option	N/A	
54 x 30 x 30	150	SPC5430DR020W		2826	SPC5430DR020G		2826	"M" Option	N/A	
<b>Left Pedestal (Right Hookup)</b>										
72 x 30 x 30	210	SPC7230DR019W		3072	SPC7230DR019G		3072	"M" Option	N/A	
66 x 30 x 30	190	SPC6630DR019W		2902	SPC6630DR019G		2902	"M" Option	N/A	
60 x 30 x 30	170	SPC6030DR019W		2867	SPC6030DR019G		2867	"M" Option	N/A	
54 x 30 x 30	150	SPC5430DR019W		2826	SPC5430DR019G		2826	"M" Option	N/A	

**2 SELECT A FINISH**

"W" Veneer	"G" HPL	"M" TFL	Finish
WAC	GAC	-	Amber Cherry
WRC	-	-	Caramel Cherry
WIC	GIC	-	Crimson Cherry
WEC	-	-	Ebony Cherry
WHC	GHC	-	Honey Cherry
WOC	GOC	-	KoKo Cherry
WSC	-	-	Scotch Cherry
WAM	GAM	-	Alabaster Maple
WCM	GCM	-	Clear Maple
WWM	GWM	-	Wheat Maple
WBO	-	-	Blush Oak
WMO	-	-	Mocha Oak
WTO	-	-	Toast Oak
WWO	-	-	Wheat Oak
WEW	GEW	-	Executive Walnut
WRW	GRW	-	Gray Luster Walnut
WGW	-	-	Gunstock Walnut
WJW	-	-	Judicial Walnut
WNW	GNW	-	Natural Walnut
WTW	GTW	-	Studio Teak Walnut
WWP	GWL	-	Designer White

**3 SELECT AN EDGE**



Undercut Bevel

**4 SELECT HARDWARE**

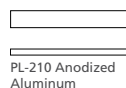

PL-210 Anodized Aluminum



PL-250 Aluminum

**5 OPTIONS**

**ACCESSORIES**

- K1: Center Drawer - \$275
- K28: Articulating Keyboard w/ Mouse - \$375

**DRAWER**

- P6: Modify Box/Box/File to File/File - \$50 per pedestal

**FEET**

- D8: Delete feet and extend fronts to floor - N/C

**FLUSH FRONT CHASSIS**

- MODCX: Breakfront chassis converted to flush front chassis - N/C

**GROMMETS (STANDARD LOCATION)**

- Specify Color and Location Right/Left - \$45 ea.
- Black: TM30-R (Right), TM30-L (Left)
- Silver: TM31-R (Right), TM31-L (Left)

**GROMMETS (NON-STANDARD LOCATION)**

- Provide drawing w/ Grommet Location and Specify Color - \$90 ea.
- Black: TM30-NS
- Silver: TM31-NS

**MODESTY**

- Full Modesty:
- M-40FG: Mini-Frame Frosted Glass - \$495
- M-40WG: Mini-Frame White Glass - \$695

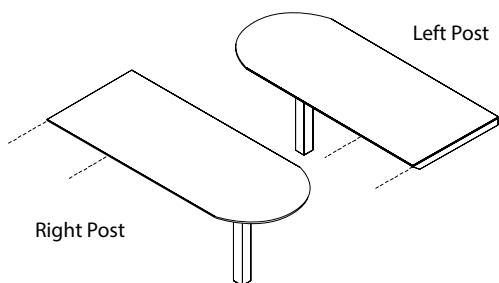

**CONFERENCE BULLET**

**STANDARD FEATURES**

- 3" Square anodized aluminum post leg
- Hookup hardware

**NOTES**

- For use with workstation credenzas
- "P" Tops and Bullets are not intended to be freestanding

[CLICK HERE TO VIEW PRODUCT INDEX](#)

**1 SELECT A STYLE**

DIMENSIONS		STYLE NUMBER	LIST PRICE	STYLE NUMBER	LIST PRICE	STYLE NUMBER	LIST PRICE
W" x D" x H"	WGT	"W" Veneer Veneer Top Veneer Chassis		"G" HPL High Pressure Laminate Top Veneer Chassis		"M" TFL Thermally Fused Laminate Top Thermally Fused Laminate Chassis	
<b>Right Post Leg (Left Hookup)</b>							
72 x 30 x 30	90	SPC7230DR744W	2908	SPC7230DR744G	2908	"M" Option N/A	
66 x 30 x 30	80	SPC6630DR744W	2851	SPC6630DR744G	2851	"M" Option N/A	
60 x 30 x 30	70	SPC6030DR744W	2795	SPC6030DR744G	2795	"M" Option N/A	
54 x 30 x 30	60	SPC5430DR744W	2738	SPC5430DR744G	2738	"M" Option N/A	
<b>Left Post Leg (Right Hookup)</b>							
72 x 30 x 30	90	SPC7230DR745W	2908	SPC7230DR745G	2908	"M" Option N/A	
66 x 30 x 30	80	SPC6630DR745W	2851	SPC6630DR745G	2851	"M" Option N/A	
60 x 30 x 30	70	SPC6030DR745W	2795	SPC6030DR745G	2795	"M" Option N/A	
54 x 30 x 30	60	SPC5430DR745W	2738	SPC5430DR745G	2738	"M" Option N/A	

**2 SELECT A FINISH**

"W" Veneer	"G" HPL	"M" TFL	Finish
WAC	GAC	-	Amber Cherry
WRC	-	-	Caramel Cherry
WIC	GIC	-	Crimson Cherry
WEC	-	-	Ebony Cherry
WHC	GHC	-	Honey Cherry
WOC	GOC	-	KoKo Cherry
WSC	-	-	Scotch Cherry
WAM	GAM	-	Alabaster Maple
WCM	GCM	-	Clear Maple
WWM	GWM	-	Wheat Maple
WBO	-	-	Blush Oak
WMO	-	-	Mocha Oak
WTO	-	-	Toast Oak
WWO	-	-	Wheat Oak
WEW	GEW	-	Executive Walnut
WRW	GRW	-	Gray Luster Walnut
WGW	-	-	Gunstock Walnut
WJW	-	-	Judicial Walnut
WNW	GNW	-	Natural Walnut
WTW	GTW	-	Studio Teak Walnut
WWP	GWL	-	Designer White

**3 SELECT AN EDGE**



Undercut Bevel

**4 SELECT HARDWARE**

Hardware Option Not Available

**5 OPTIONS**

**ACCESSORIES**

- K1: Center Drawer - \$275
- K2: Center Drawer w/ Skirt - \$375
- K28: Articulating Keyboard w/ Mouse - \$375

**GROMMETS (STANDARD LOCATION)**

- Specify Color - \$45 ea.
- Black: TM30-C (Center)
- Silver: TM31-C (Center)

**GROMMETS (NON-STANDARD LOCATION)**

- Provide drawing w/ Grommet Location and Specify Color - \$90 ea.
- Black: TM30-NS
- Silver: TM31-NS

**MODESTY**

- Full Modesty:
  - M-44CW: Curved Wood - \$395
- Half Modesty:
  - HM-44CW: Curved Wood - \$295
  - HM-40FG: Mini-Frame Frosted Glass - \$395
  - HM-40WG: Mini-Frame White Glass - \$495

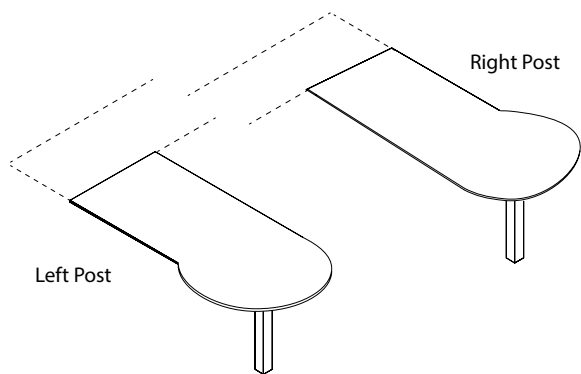

**CONFERENCE "P"**

**STANDARD FEATURES**

- 3" Square anodized aluminum post leg
- Hookup hardware

**NOTES**

- For use with workstation credenzas
- "P" Tops and Bullets are not intended to be freestanding

[CLICK HERE TO VIEW PRODUCT INDEX](#)

**1 SELECT A STYLE**

DIMENSIONS		STYLE NUMBER	LIST PRICE	STYLE NUMBER	LIST PRICE	STYLE NUMBER	LIST PRICE
W" x D" x H"	WGT	"W" Veneer Veneer Top Veneer Chassis		"G" HPL High Pressure Laminate Top Veneer Chassis		"M" TFL Thermally Fused Laminate Top Thermally Fused Laminate Chassis	
<b>Right Post Leg (Left Hookup)</b>							
72 x 30/36 x 30	100	SPC7236DR746W	3247	SPC7236DR746G	3247	"M" Option N/A	
66 x 30/36 x 30	90	SPC6636DR746W	3190	SPC6636DR746G	3190	"M" Option N/A	
60 x 30/36 x 30	80	SPC6036DR746W	3134	SPC6036DR746G	3134	"M" Option N/A	
54 x 30/36 x 30	70	SPC5436DR746W	3077	SPC5436DR746G	3077	"M" Option N/A	
<b>Left Post Leg (Right Hookup)</b>							
72 x 30/36 x 30	100	SPC7236DR747W	3247	SPC7236DR747G	3247	"M" Option N/A	
66 x 30/36 x 30	90	SPC6636DR747W	3190	SPC6636DR747G	3190	"M" Option N/A	
60 x 30/36 x 30	80	SPC6036DR747W	3134	SPC6036DR747G	3134	"M" Option N/A	
54 x 30/36 x 30	70	SPC5436DR747W	3077	SPC5436DR747G	3077	"M" Option N/A	

**2 SELECT A FINISH**

"W" Veneer	"G" HPL	"M" TFL	Finish
WAC	GAC	-	Amber Cherry
WRC	-	-	Caramel Cherry
WIC	GIC	-	Crimson Cherry
WEC	-	-	Ebony Cherry
WHC	GHC	-	Honey Cherry
WOC	GOC	-	KoKo Cherry
WSC	-	-	Scotch Cherry
WAM	GAM	-	Alabaster Maple
WCM	GCM	-	Clear Maple
WWM	GWM	-	Wheat Maple
WBO	-	-	Blush Oak
WMO	-	-	Mocha Oak
WTO	-	-	Toast Oak
WWO	-	-	Wheat Oak
WEW	GEW	-	Executive Walnut
WRW	GRW	-	Gray Luster Walnut
WGW	-	-	Gunstock Walnut
WJW	-	-	Judicial Walnut
WNW	GNW	-	Natural Walnut
WTW	GTW	-	Studio Teak Walnut
WWP	GWL	-	Designer White

**3 SELECT AN EDGE**



Undercut Bevel

**4 SELECT HARDWARE**

Hardware Option Not Available

**5 OPTIONS**

**ACCESSORIES**

- K1: Center Drawer - \$275
- K2: Center Drawer w/ Skirt - \$375
- K28: Articulating Keyboard w/ Mouse - \$375

**GROMMETS (STANDARD LOCATION)**

- Specify Color - \$45 ea.
- Black: TM30-C (Center)
- Silver: TM31-C (Center)

**GROMMETS (NON-STANDARD LOCATION)**

- Provide drawing w/ Grommet Location and Specify Color - \$90 ea.
- Black: TM30-NS
- Silver: TM31-NS

**MODESTY**

- Full Modesty:
  - M-44CW: Curved Wood - \$395
- Half Modesty:
  - HM-44CW: Curved Wood - \$295
  - HM-40FG: Mini-Frame Frosted Glass - \$395
  - HM-40WG: Mini-Frame White Glass - \$495

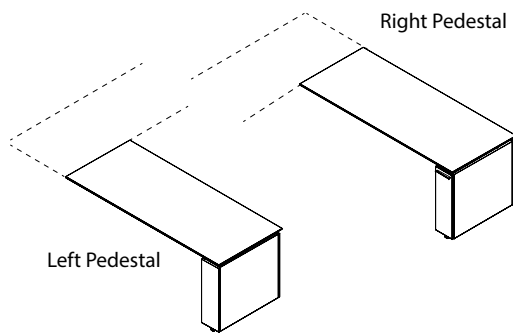

**CONFERENCE - ORGANIZER PEDESTAL**

**STANDARD FEATURES**

- 8"W Organizer Tower Pedestal
- Anodized aluminum feet
- Tower accessories include pencil tray, cd holder, hanging folder brackets, large and small trays

**NOTES**

- Lock is unable to be added to this drawer

[CLICK HERE TO VIEW PRODUCT INDEX](#)

**1 SELECT A STYLE**

DIMENSIONS		STYLE NUMBER	LIST PRICE	STYLE NUMBER	LIST PRICE	STYLE NUMBER	LIST PRICE
W" x D" x H"	WGT	"W" Veneer Veneer Top Veneer Chassis		"G" HPL High Pressure Laminate Top Veneer Chassis		"M" TFL Thermally Fused Laminate Top Thermally Fused Laminate Chassis	
<b>Right Pedestal (Left Hookup)</b>							
72 x 30 x 30	160	SPC7230DR707W	3134	SPC7230DR707G	3134	"M" Option N/A	
66 x 30 x 30	150	SPC6630DR707W	3077	SPC6630DR707G	3077	"M" Option N/A	
60 x 30 x 30	140	SPC6030DR707W	3052	SPC6030DR707G	3052	"M" Option N/A	
54 x 30 x 30	130	SPC5430DR707W	3021	SPC5430DR707G	3021	"M" Option N/A	
<b>Left Pedestal (Right Hookup)</b>							
72 x 30 x 30	160	SPC7230DR708W	3134	SPC7230DR708G	3134	"M" Option N/A	
66 x 30 x 30	150	SPC6630DR708W	3077	SPC6630DR708G	3077	"M" Option N/A	
60 x 30 x 30	140	SPC6030DR708W	3052	SPC6030DR708G	3052	"M" Option N/A	
54 x 30 x 30	130	SPC5430DR708W	3021	SPC5430DR708G	3021	"M" Option N/A	

**2 SELECT A FINISH**

"W" Veneer	"G" HPL	"M" TFL	Finish
WAC	GAC	-	Amber Cherry
WRC	-	-	Caramel Cherry
WIC	GIC	-	Crimson Cherry
WEC	-	-	Ebony Cherry
WHC	GHC	-	Honey Cherry
WOC	GOC	-	KoKo Cherry
WSC	-	-	Scotch Cherry
WAM	GAM	-	Alabaster Maple
WCM	GCM	-	Clear Maple
WWM	GWM	-	Wheat Maple
WBO	-	-	Blush Oak
WMO	-	-	Mocha Oak
WTO	-	-	Toast Oak
WWO	-	-	Wheat Oak
WEW	GEW	-	Executive Walnut
WRW	GRW	-	Gray Luster Walnut
WGW	-	-	Gunstock Walnut
WJW	-	-	Judicial Walnut
WNW	GNW	-	Natural Walnut
WTW	GTW	-	Studio Teak Walnut
WWP	GWL	-	Designer White

**3 SELECT AN EDGE**



Undercut Bevel

**4 SELECT HARDWARE**

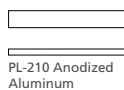

PL-210 Anodized Aluminum



PL-250 Aluminum

**5 OPTIONS**

**ACCESSORIES**

- K1: Center Drawer - \$275
- K28: Articulating Keyboard w/ Mouse - \$375

**FEET**

- D8: Delete feet and extend fronts to floor - N/C

**GROMMETS (STANDARD LOCATION)**

- Specify Color and Location Right/Left - \$45 ea.
- Black: TM30-R (Right), TM30-L (Left)
- Silver: TM31-R (Right), TM31-L (Left)

**GROMMETS (NON-STANDARD LOCATION)**

- Provide drawing w/ Grommet Location and Specify Color - \$90 ea.
- Black: TM30-NS
- Silver: TM31-NS

**MODESTY**

- Half Modesty:
- HM-1: Half-wood Modesty - \$195
- HM-40FG: Mini-Frame Frosted Glass - \$395
- HM-40WG: Mini-Frame White Glass - \$495

"L" WORKSTATION RETURNS

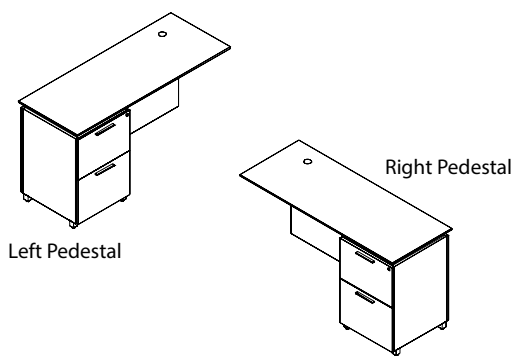

FILE/FILE

STANDARD FEATURES

- 1 Standard grommet - matches pull finish or specify black TM30 or silver TM31
- Anodized aluminum feet
- Full extension drawers - locking
- Hookup hardware
- Soft close suspension drawer(s)
- Top shaped 3 edges & coped on hookup

- Right pedestal gets left grommet

NOTES

- Left pedestal gets right grommet

[CLICK HERE TO VIEW PRODUCT INDEX](#)

1 SELECT A STYLE

DIMENSIONS		STYLE NUMBER	LIST PRICE	STYLE NUMBER	LIST PRICE	STYLE NUMBER	LIST PRICE
W" x D" x H"	WGT	"W" Veneer Top Veneer Chassis		"G" High Pressure Laminate Top Veneer Chassis		"M" Thermally Fused Laminate Top Thermally Fused Laminate Chassis	
<b>Left Pedestal (Left Hookup)</b>							
60 x 24 x 30	185	SPC6024RE195W	2569	SPC6024RE195G	2569	"M" Option N/A	
54 x 24 x 30	175	SPC5424RE195W	2512	SPC5424RE195G	2512	"M" Option N/A	
48 x 24 x 30	165	SPC4824RE195W	2456	SPC4824RE195G	2456	"M" Option N/A	
42 x 24 x 30	150	SPC4224RE195W	2400	SPC4224RE195G	2400	"M" Option N/A	
<b>Right Pedestal (Right Hookup)</b>							
60 x 24 x 30	185	SPC6024RE196W	2569	SPC6024RE196G	2569	"M" Option N/A	
54 x 24 x 30	175	SPC5424RE196W	2512	SPC5424RE196G	2512	"M" Option N/A	
48 x 24 x 30	165	SPC4824RE196W	2456	SPC4824RE196G	2456	"M" Option N/A	
42 x 24 x 30	150	SPC4224RE196W	2400	SPC4224RE196G	2400	"M" Option N/A	

2 SELECT A FINISH

"W" Veneer	"G" HPL	"M" TFL	
WAC	GAC	-	Amber Cherry
WRC	-	-	Caramel Cherry
WIC	GIC	-	Crimson Cherry
WEC	-	-	Ebony Cherry
WHC	GHC	-	Honey Cherry
WOC	GOC	-	KoKo Cherry
WSC	-	-	Scotch Cherry
WAM	GAM	-	Alabaster Maple
WCM	GCM	-	Clear Maple
WWM	GWM	-	Wheat Maple
WBO	-	-	Blush Oak
WMO	-	-	Mocha Oak
WTO	-	-	Toast Oak
WWO	-	-	Wheat Oak
WEW	GEW	-	Executive Walnut
WRW	GRW	-	Gray Luster Walnut
WGW	-	-	Gunstock Walnut
WJW	-	-	Judicial Walnut
WNW	GNW	-	Natural Walnut
WTW	GTW	-	Studio Teak Walnut
WWP	GWL	-	Designer White

3 SELECT AN EDGE



Undercut Bevel

4 SELECT HARDWARE

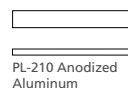

PL-210 Anodized Aluminum



PL-250 Aluminum

5 OPTIONS

ACCESSORIES

- K1: Center Drawer - \$275
- K28: Articulating Keyboard w/ Mouse - \$375

DRAWER

- P6: Modify File/File to Box/Box/File - \$50 per pedestal
- P40W: "W" extra Box/Box/File or File/File to kneespace - \$875

FEET

- D8: Delete feet and extend fronts to floor - N/C

FLUSH CUT

- FC-L: Flush Unit Left (Facing) for Ganging - N/C
- FC-R: Flush Unit Right(Facing) for Ganging - N/C

GROMMETS (NON-STANDARD LOCATION)

- Provide drawing w/ Grommet Location and Specify Color - \$90 ea.
- Black: TM30-NS
- Silver: TM31-NS

MODESTY

- M34T: "W" "G" Style Drop Door Tech Modesty - \$125
- M37P: Partial Height Modesty - \$95
- M51: Open Back Modesty with Wire Mgmt Rail - Deduct \$95

"L" WORKSTATION RETURNS

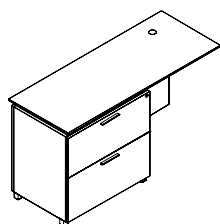

Left Pedestal

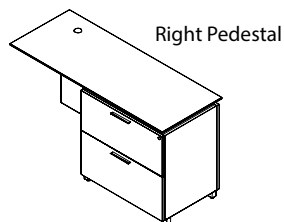

Right Pedestal

LATERAL FILE

STANDARD FEATURES

- 1 Standard grommet - matches pull finish or specify black TM30 or silver TM31
- Anodized aluminum feet
- Fixed full wood modesty
- Full extension drawers - locking
- Hookup hardware
- Soft close suspension drawer(s)
- Top shaped 3 edges & coped on hookup

- Keyboards Not available on 48" units
- Left pedestal gets right grommet
- Right pedestal gets left grommet

NOTES

[CLICK HERE TO VIEW PRODUCT INDEX](#)

1 SELECT A STYLE

DIMENSIONS		STYLE NUMBER	LIST PRICE	STYLE NUMBER	LIST PRICE	STYLE NUMBER	LIST PRICE
W" x D" x H"	WGT	"W" Veneer Top Veneer Chassis		"G" High Pressure Laminate Top Veneer Chassis		"M" Thermally Fused Laminate Top Thermally Fused Laminate Chassis	
<b>Left Pedestal (Left Hookup)</b>							
60 x 24 x 30	205	SPC6024RE187W	3021	SPC6024RE187G	3021	"M" Option N/A	
54 x 24 x 30	190	SPC5424RE187W	2964	SPC5424RE187G	2964	"M" Option N/A	
48 x 24 x 30	180	SPC4824RE187W	2908	SPC4824RE187G	2908	"M" Option N/A	
<b>Right Pedestal (Right Hookup)</b>							
60 x 24 x 30	205	SPC6024RE188W	3021	SPC6024RE188G	3021	"M" Option N/A	
54 x 24 x 30	190	SPC5424RE188W	2964	SPC5424RE188G	2964	"M" Option N/A	
48 x 24 x 30	180	SPC4824RE188W	2908	SPC4824RE188G	2908	"M" Option N/A	

2 SELECT A FINISH

"W" Veneer	"G" HPL	"M" TFL	
WAC	GAC	-	Amber Cherry
WRC	-	-	Caramel Cherry
WIC	GIC	-	Crimson Cherry
WEC	-	-	Ebony Cherry
WHC	GHC	-	Honey Cherry
WOC	GOC	-	KoKo Cherry
WSC	-	-	Scotch Cherry
WAM	GAM	-	Alabaster Maple
WCM	GCM	-	Clear Maple
WWM	GWM	-	Wheat Maple
WBO	-	-	Blush Oak
WMO	-	-	Mocha Oak
WTO	-	-	Toast Oak
WWO	-	-	Wheat Oak
WEW	GEW	-	Executive Walnut
WRW	GRW	-	Gray Luster Walnut
WGW	-	-	Gunstock Walnut
WJW	-	-	Judicial Walnut
WNW	GNW	-	Natural Walnut
WTW	GTW	-	Studio Teak Walnut
WWP	GWL	-	Designer White

3 SELECT AN EDGE



Undercut Bevel

4 SELECT HARDWARE

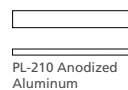

PL-210 Anodized Aluminum



PL-250 Aluminum

5 OPTIONS

ACCESSORIES

- K1: Center Drawer - \$275
- K28: Articulating Keyboard w/ Mouse - \$375

DRAWER

- P40W: "W" extra Box/Box/File or File/File to kneespace - \$875

FEET

- D8: Delete feet and extend fronts to floor - N/C

FLUSH CUT

- FC-L: Flush Unit Left (Facing) for Ganging - N/C
- FC-R: Flush Unit Right (Facing) for Ganging - N/C

GROMMETS (NON-STANDARD LOCATION)

- Provide drawing w/ Grommet Location and Specify Color - \$90 ea.
- Black: TM30-NS
- Silver: TM31-NS

MODESTY

- M34T: "W" "G" Style Drop Door Tech Modesty - \$125
- M37P: Partial Height Modesty - \$95
- M51: Open Back Modesty with Wire Mgmt Rail - Deduct \$95



"L" WORKSTATION RETURNS

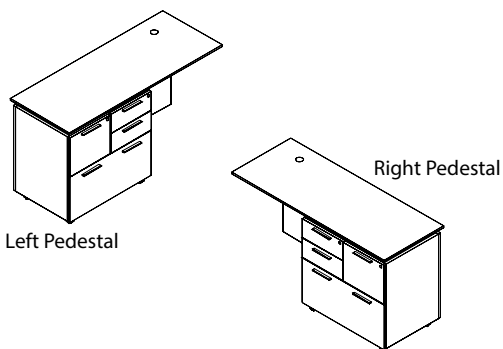

**BOX / BOX / FILE / LATERAL**

**STANDARD FEATURES**

- 1 Standard grommet - matches pull finish or specify black TM30 or silver TM31
- Anodized aluminum feet
- Full extension drawers - locking
- Hookup hardware
- Soft close suspension drawer(s)
- Top shaped 3 edges & coped on hookup

- Right pedestal gets left grommet

**NOTES**

- Left pedestal gets right grommet

[CLICK HERE TO VIEW PRODUCT INDEX](#)

**1 SELECT A STYLE**

DIMENSIONS		STYLE NUMBER	LIST PRICE	STYLE NUMBER	LIST PRICE	STYLE NUMBER	LIST PRICE
W" x D" x H"	WGT	"W" Veneer Top Veneer Chassis		"G" HPL High Pressure Laminate Top Veneer Chassis		"M" TFL Thermally Fused Laminate Top Thermally Fused Laminate Chassis	
<b>Left Pedestal (Left Hookup)</b>							
60 x 24 x 30	205	SPC6024RE218W	3247	SPC6024RE218G	3247	"M" Option N/A	
54 x 24 x 30	190	SPC5424RE218W	3190	SPC5424RE218G	3190	"M" Option N/A	
48 x 24 x 30	180	SPC4824RE218W	3134	SPC4824RE218G	3134	"M" Option N/A	
<b>Right Pedestal (Right Hookup)</b>							
60 x 24 x 30	205	SPC6024RE219W	3247	SPC6024RE219G	3247	"M" Option N/A	
54 x 24 x 30	190	SPC5424RE219W	3190	SPC5424RE219G	3190	"M" Option N/A	
48 x 24 x 30	180	SPC4824RE219W	3134	SPC4824RE219G	3134	"M" Option N/A	

**2 SELECT A FINISH**

"W" Veneer	"G" HPL	"M" TFL	
WAC	GAC	-	Amber Cherry
WRC	-	-	Caramel Cherry
WIC	GIC	-	Crimson Cherry
WEC	-	-	Ebony Cherry
WHC	GHC	-	Honey Cherry
WOC	GOC	-	KoKo Cherry
WSC	-	-	Scotch Cherry
WAM	GAM	-	Alabaster Maple
WCM	GCM	-	Clear Maple
WWM	GWM	-	Wheat Maple
WBO	-	-	Blush Oak
WMO	-	-	Mocha Oak
WTO	-	-	Toast Oak
WWO	-	-	Wheat Oak
WEW	GEW	-	Executive Walnut
WRW	GRW	-	Gray Luster Walnut
WGW	-	-	Gunstock Walnut
WJW	-	-	Judicial Walnut
WNW	GNW	-	Natural Walnut
WTW	GTW	-	Studio Teak Walnut
WWP	GWL	-	Designer White

**3 SELECT AN EDGE**



Undercut Bevel

**4 SELECT HARDWARE**

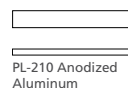

PL-210 Anodized Aluminum



PL-250 Aluminum

**5 OPTIONS**

**ACCESSORIES**

- K1: Center Drawer - \$275
- K28: Articulating Keyboard w/ Mouse - \$375

**FEET**

- D8: Delete feet and extend fronts to floor - N/C

**GROMMETS (NON-STANDARD LOCATION)**

- Provide drawing w/ Grommet Location and Specify Color - \$90 ea.
- Black: TM30-NS
- Silver: TM31-NS

**FLUSH CUT**

- FC-L: Flush Unit Left (Facing) for Ganging - N/C
- FC-R: Flush Unit Right(Facing) for Ganging - N/C

**MODESTY**

- M34T: "W" "G" Style Drop Door Tech Modesty - \$125
- M37P: Partial Height Modesty - \$95
- M51: Open Back Modesty with Wire Mgmt Rail - Deduct \$95

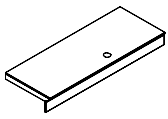

**OPEN BACK**

**STANDARD FEATURES**

- 1 Standard grommet - matches pull finish or specify black TM30 or silver TM31
- J channel wire management

[CLICK HERE TO VIEW PRODUCT INDEX](#)

**1 SELECT A STYLE**

DIMENSIONS		STYLE NUMBER	LIST PRICE	STYLE NUMBER	LIST PRICE	STYLE NUMBER	LIST PRICE
W" x D" x H"	WGT	"W" Veneer Veneer Top Veneer Chassis		"G" HPL High Pressure Laminate Top Veneer Chassis		"M" TFL Thermally Fused Laminate Top Thermally Fused Laminate Chassis	
60 x 24 x 30	65	SPC6024BR151W	1305	SPC6024BR151G	1305	"M" Option N/A	
54 x 24 x 30	60	SPC5424BR151W	1212	SPC5424BR151G	1212	"M" Option N/A	
48 x 24 x 30	55	SPC4824BR151W	1167	SPC4824BR151G	1167	"M" Option N/A	
42 x 24 x 30	50	SPC4224BR151W	1110	SPC4224BR151G	1110	"M" Option N/A	

**2 SELECT A FINISH**

"W" Veneer	"G" HPL	"M" TFL	
WAC	GAC	-	Amber Cherry
WRC	-	-	Caramel Cherry
WIC	GIC	-	Crimson Cherry
WEC	-	-	Ebony Cherry
WHC	GHC	-	Honey Cherry
WOC	GOC	-	KoKo Cherry
WSC	-	-	Scotch Cherry
WAM	GAM	-	Alabaster Maple
WCM	GCM	-	Clear Maple
WWM	GWM	-	Wheat Maple
WBO	-	-	Blush Oak
WMO	-	-	Mocha Oak
WTO	-	-	Toast Oak
WWO	-	-	Wheat Oak
WEW	GEW	-	Executive Walnut
WRW	GRW	-	Gray Luster Walnut
WGW	-	-	Gunstock Walnut
WJW	-	-	Judicial Walnut
WNW	GNW	-	Natural Walnut
WTW	GTW	-	Studio Teak Walnut
WWP	GWL	-	Designer White

**3 SELECT AN EDGE**



Undercut Bevel

**4 SELECT HARDWARE**

Hardware Option Not Available

**5 OPTIONS**

**ACCESSORIES**

- K28: Articulating Keyboard w/ Mouse - \$375

**GROMMETS (NON-STANDARD LOCATION)**

- Provide drawing w/ Grommet Location and Specify Color - \$90 ea.
- Black: TM30-NS
- Silver: TM31-NS

**MODESTY**

- M34T-O: "W" "G" Style Drop Door Tech Modesty - \$295
- M37: "W" "G" Style Fixed Full Modesty - \$125

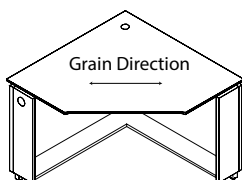

**CORNER UNIT**

**STANDARD FEATURES**

- 1 Standard grommet - matches pull finish or specify black TM30 or silver TM31
- Anodized aluminum feet

**NOTES**

- For use w/ bridges & returns

[CLICK HERE TO VIEW PRODUCT INDEX](#)

**1 SELECT A STYLE**

DIMENSIONS		STYLE NUMBER	LIST PRICE	STYLE NUMBER	LIST PRICE	STYLE NUMBER	LIST PRICE
W" x D" x H"	WGT	"W" Veneer Top Veneer Chassis		"G" HPL High Pressure Laminate Top Veneer Chassis		"M" TFL Thermally Fused Laminate Top Thermally Fused Laminate Chassis	
42 x 42 x 30	175	SPC4242CU228W	2569	SPC4242CU228G	2569	"M" Option N/A	
48 x 48 x 30		SPC4848CU228W	2919	SPC4848CU228G	2919	"M" Option N/A	

**2 SELECT A FINISH**

"W" Veneer	"G" HPL	"M" TFL	
WAC	GAC	-	Amber Cherry
WRC	-	-	Caramel Cherry
WIC	GIC	-	Crimson Cherry
WEC	-	-	Ebony Cherry
WHC	GHC	-	Honey Cherry
WOC	GOC	-	KoKo Cherry
WSC	-	-	Scotch Cherry
WAM	GAM	-	Alabaster Maple
WCM	GCM	-	Clear Maple
WWM	GWM	-	Wheat Maple
WBO	-	-	Blush Oak
WMO	-	-	Mocha Oak
WTO	-	-	Toast Oak
WWO	-	-	Wheat Oak
WEW	GEW	-	Executive Walnut
WRW	GRW	-	Gray Luster Walnut
WGW	-	-	Gunstock Walnut
WJW	-	-	Judicial Walnut
WNW	GNW	-	Natural Walnut
WTW	GTW	-	Studio Teak Walnut
WWP	GWL	-	Designer White

**3 SELECT AN EDGE**



Undercut Bevel

**4 SELECT HARDWARE**

Hardware Option Not Available

**5 OPTIONS**

**ACCESSORIES**

- K1: Center Drawer - \$275
- K28: Articulating Keyboard w/ Mouse - \$375

**FEET**

- D8: Delete feet and extend fronts to floor - N/C

**GROMMETS (NON-STANDARD LOCATION)**

Provide drawing w/ Grommet Location and Specify Color - \$90 ea.  
 - Black: TM30-NS  
 - Silver: TM31-NS

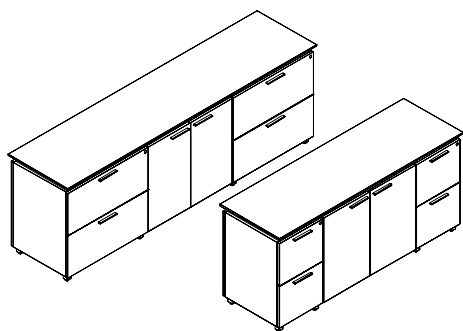

**FILE STORAGE**

**STANDARD FEATURES**

- Adjustable black shelf behind each door section
- Anodized aluminum feet
- Full extension drawers - locking
- Soft close suspension drawer(s)
- Top profile shaped 4 sides

**NOTES**

- Unit not designed for open plan use. Select OPB Option for Open Plan application

[CLICK HERE TO VIEW PRODUCT INDEX](#)

**1 SELECT A STYLE**

DIMENSIONS		STYLE NUMBER	LIST PRICE	STYLE NUMBER	LIST PRICE	STYLE NUMBER	LIST PRICE
W" x D" x H"	WGT	"W" Veneer Veneer Top Veneer Chassis		"G" HPL High Pressure Laminate Top Veneer Chassis		"M" TFL Thermally Fused Laminate Top Thermally Fused Laminate Chassis	
<b>Lateral File / Storage</b>							
94 x 24 x 30	350	SPC9424CA651W	6412	SPC9424CA651G	6412	"M" Option N/A	
88 x 24 x 30	330	SPC8824CA651W	6299	SPC8824CA651G	6299	"M" Option N/A	
<b>File / Storage</b>							
71 x 24 x 30	265	SPC7124CA050W	4038	SPC7124CA050G	4038	"M" Option N/A	
65 x 24 x 30	255	SPC6524CA050W	3868	SPC6524CA050G	3868	"M" Option N/A	

**2 SELECT A FINISH**

"W" Veneer	"G" HPL	"M" TFL	
WAC	GAC	-	Amber Cherry
WRC	-	-	Caramel Cherry
WIC	GIC	-	Crimson Cherry
WEC	-	-	Ebony Cherry
WHC	GHC	-	Honey Cherry
WOC	GOC	-	KoKo Cherry
WSC	-	-	Scotch Cherry
WAM	GAM	-	Alabaster Maple
WCM	GCM	-	Clear Maple
WWM	GWM	-	Wheat Maple
WBO	-	-	Blush Oak
WMO	-	-	Mocha Oak
WTO	-	-	Toast Oak
WWO	-	-	Wheat Oak
WEW	GEW	-	Executive Walnut
WRW	GRW	-	Gray Luster Walnut
GWG	-	-	Gunstock Walnut
WJW	-	-	Judicial Walnut
WNW	GNW	-	Natural Walnut
WTW	GTW	-	Studio Teak Walnut
WWP	GWL	-	Designer White

**3 SELECT AN EDGE**



**4 SELECT HARDWARE**

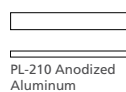

**5 OPTIONS**

**DOOR**

- D2: Door Lock - \$95 per Door Set
- D6A: "W"/"G" Styles - Delete Doors and replace black laminate shelf with finished shelf - n/c
- D95C: Soft Close Door Hinges - \$15 per Door

**DRAWER**

- P6: Modify File/File to Box/Box/File - \$50 per pedestal

**FEET**

- D8: Delete feet and extend fronts to floor - N/C

**FLUSH CUT**

- FC-B: Flush Unit Both Sides(Facing) for Ganging - N/C
- FC-L: Flush Unit Left (Facing) for Ganging - N/C
- FC-R: Flush Unit Right(Facing) for Ganging - N/C

**GROMMETS (STANDARD LOCATION)**

- Specify Color and Location (Right/Left/Center) - \$45 ea.
- Black: TM30-R (Right), TM30-L (Left), TM30-C (Center)
- Silver: TM31-R (Right), TM31-L (Left), TM31-C (Center)

**GROMMETS (NON-STANDARD LOCATION)**

- Provide drawing w/ Grommet Location and Specify Color - \$90 ea.
- Black: TM30-NS
- Silver: TM31-NS

**GROMMETS (VERTICAL GROMMET)**

- Standard Location - \$45
- Black Plastic Vertical Surface: TM50-C (Bottom Center)
- Non-Standard Location: Provide drawing w/ Grommet Location and Specify Color - \$90
- Black Plastic Vertical Surface: TM50-NS

**OPEN PLAN**

- OPB: "W" "G" Style - Modify Unit for Open Plan Application - \$195

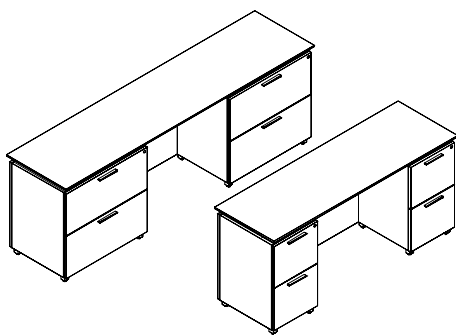

**KNEESPACE**

**STANDARD FEATURES**

- Anodized aluminum feet
- Fixed full wood modesty
- Full extension drawers - locking
- Soft close suspension drawer(s)
- Top profile shaped 4 sides

**NOTES**

- Unit not designed for open plan use. Select OPB Option for Open Plan application

[CLICK HERE TO VIEW PRODUCT INDEX](#)

**1 SELECT A STYLE**

DIMENSIONS		STYLE NUMBER	LIST PRICE	STYLE NUMBER	LIST PRICE	STYLE NUMBER	LIST PRICE
W" x D" x H"	WGT	"W" Veneer Veneer Top Veneer Chassis		"G" HPL High Pressure Laminate Top Veneer Chassis		"M" TFL Thermally Fused Laminate Top Thermally Fused Laminate Chassis	
<b>Lateral File / Lateral File</b>							
94 x 24 x 30	325	SPC9424CA052W	5959	SPC9424CA052G	5959	"M" Option N/A	
88 x 24 x 30	295	SPC8824CA052W	5846	SPC8824CA052G	5846	"M" Option N/A	
<b>File / File</b>							
71 x 24 x 30	225	SPC7124CA054W	3586	SPC7124CA054G	3586	"M" Option N/A	
65 x 24 x 30	215	SPC6524CA054W	3472	SPC6524CA054G	3472	"M" Option N/A	

**2 SELECT A FINISH**

"W" Veneer	"G" HPL	"M" TFL	
WAC	GAC	-	Amber Cherry
WRC	-	-	Caramel Cherry
WIC	GIC	-	Crimson Cherry
WEC	-	-	Ebony Cherry
WHC	GHC	-	Honey Cherry
WOC	GOC	-	KoKo Cherry
WSC	-	-	Scotch Cherry
WAM	GAM	-	Alabaster Maple
WCM	GCM	-	Clear Maple
WWM	GWM	-	Wheat Maple
WBO	-	-	Blush Oak
WMO	-	-	Mocha Oak
WTO	-	-	Toast Oak
WWO	-	-	Wheat Oak
WEW	GEW	-	Executive Walnut
WRW	GRW	-	Gray Luster Walnut
GWG	-	-	Gunstock Walnut
WJW	-	-	Judicial Walnut
WNW	GNW	-	Natural Walnut
WTW	GTW	-	Studio Teak Walnut
WWP	GWL	-	Designer White

**3 SELECT AN EDGE**



**4 SELECT HARDWARE**

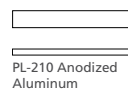

**5 OPTIONS**

**ACCESSORIES**

- K1: Center Drawer - \$275

**DRAWER**

- P6: Modify File/File to Box/Box/File - \$50 per pedestal

**FEET**

- D8: Delete feet and extend fronts to floor - N/C

**FLUSH CUT**

- FC-B: Flush Unit Both Sides (Facing) for Ganging - N/C
- FC-L: Flush Unit Left (Facing) for Ganging - N/C
- FC-R: Flush Unit Right (Facing) for Ganging - N/C

**GROMMETS (STANDARD LOCATION)**

- Specify Color - \$45 ea.
- Black: TM30-C (Center)
  - Silver: TM31-C (Center)

**GROMMETS (NON-STANDARD LOCATION)**

- Provide drawing w/ Grommet Location and Specify Color - \$90 ea.
- Black: TM30-NS
  - Silver: TM31-NS

**MODESTY**

- M34T: "W" "G" Style Drop Door Tech Modesty - \$125
- M37P: Partial Height Modesty - \$95
- M51: Open Back Modesty with Wire Mgmt Rail - Deduct \$95

**OPEN PLAN**

- OPB: "W" "G" Style - Modify Unit for Open Plan Application - \$195

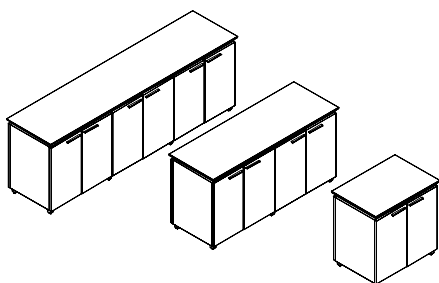

**6 / 4 / 2 DOOR STORAGE**

**STANDARD FEATURES**

- Adjustable black shelf behind each door section
- Anodized aluminum feet
- Top profile shaped 4 sides

**NOTES**

- Unit not designed for open plan use. Select OPB Option for Open Plan application

[CLICK HERE TO VIEW PRODUCT INDEX](#)

**1 SELECT A STYLE**

DIMENSIONS		STYLE NUMBER		LIST PRICE	STYLE NUMBER		LIST PRICE	STYLE NUMBER		LIST PRICE
W" x D" x H"	WGT	"W" Veneer	Veneer Top Veneer Chassis		"G" HPL	High Pressure Laminate Top Veneer Chassis		"M" TFL	Thermally Fused Laminate Top Thermally Fused Laminate Chassis	
<b>6 Door</b>										
94 x 24 x 30	325	SPC9424CA125W		5409	SPC9424CA125G		5409	"M" Option	N/A	
88 x 24 x 30	295	SPC8824CA125W		5327	SPC8824CA125G		5327	"M" Option	N/A	
<b>4 Door</b>										
71 x 24 x 30	225	SPC7124CA125W		4038	SPC7124CA125G		4038	"M" Option	N/A	
59 x 24 x 30	210	SPC5924CA125W		3924	SPC5924CA125G		3924	"M" Option	N/A	
<b>2 Door</b>										
36 x 24 x 30	130	SPC3624CA125W		1948	SPC3624CA125G		1948	"M" Option	N/A	
30 x 24 x 30	115	SPC3024CA125W		1891	SPC3024CA125G		1891	"M" Option	N/A	

**2 SELECT A FINISH**

"W" Veneer	"G" HPL	"M" TFL	
WAC	GAC	-	Amber Cherry
WRC	-	-	Caramel Cherry
WIC	GIC	-	Crimson Cherry
WEC	-	-	Ebony Cherry
WHC	GHC	-	Honey Cherry
WOC	GOC	-	KoKo Cherry
WSC	-	-	Scotch Cherry
WAM	GAM	-	Alabaster Maple
WCM	GCM	-	Clear Maple
WWM	GWM	-	Wheat Maple
WBO	-	-	Blush Oak
WMO	-	-	Mocha Oak
WTO	-	-	Toast Oak
WWO	-	-	Wheat Oak
WEW	GEW	-	Executive Walnut
WRW	GRW	-	Gray Luster Walnut
GWG	-	-	Gunstock Walnut
WJW	-	-	Judicial Walnut
WNW	GNW	-	Natural Walnut
WTW	GTW	-	Studio Teak Walnut
WWP	GWL	-	Designer White

**3 SELECT AN EDGE**



**4 SELECT HARDWARE**

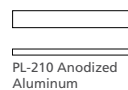

**5 OPTIONS**

- DOOR**
- D2: Door Lock - \$95 per Door Set
  - D6A: "W"/"G" Styles - Delete Doors and replace black laminate shelf with finished shelf - n/c
  - D95C: Soft Close Door Hinges - \$15 per Door
- FEET**
- D8: Delete feet and extend fronts to floor - N/C
- FLUSH CUT**
- FC-B: Flush Unit Both Sides(Facing) for Ganging - N/C
  - FC-L: Flush Unit Left (Facing) for Ganging - N/C
  - FC-R: Flush Unit Right(Facing) for Ganging - N/C
- GROMMETS (STANDARD LOCATION)**
- Specify Color and Location (Right/Left/Center) - \$45 ea.
- Black: TM30-R (Right), TM30-L (Left), TM30-C (Center)
  - Silver: TM31-R (Right), TM31-L (Left), TM31-C (Center)
- GROMMETS (NON-STANDARD LOCATION)**
- Provide drawing w/ Grommet Location and Specify Color - \$90 ea.
- Black: TM30-NS
  - Silver: TM31-NS
- GROMMETS (VERTICAL SURFACE)**
- Standard Location - \$45 ea.
- Black Plastic Vertical Surface: TM50-C (Bottom Center)
  - Non-Standard Location - \$90 ea.
  - Black Plastic Vertical Surface: TM50-NS
- OPEN PLAN**
- OPB: "W" "G" Style - Modify Unit for Open Plan Application - \$195

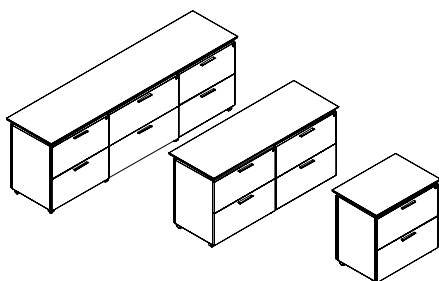

**6 / 4 / 2 DRAWER**

**STANDARD FEATURES**

- Anodized aluminum feet
- Anti-tilt safety feature
- Full extension drawers - locking
- Legal/Letter filing
- Soft close suspension drawer(s)

**NOTES**

- Unit not designed for open plan use. Select OPB Option for Open Plan application

[CLICK HERE TO VIEW PRODUCT INDEX](#)

**1 SELECT A STYLE**

DIMENSIONS		STYLE NUMBER		LIST PRICE	STYLE NUMBER		LIST PRICE	STYLE NUMBER		LIST PRICE
W" x D" x H"	WGT	"W" Veneer	Veneer Top Veneer Chassis		"G" HPL	High Pressure Laminate Top Veneer Chassis		"M" TFL	Thermally Fused Laminate Top Thermally Fused Laminate Chassis	
<b>6 Drawer</b>										
94 x 24 x 30	410	SPC9424CA104W		7315	SPC9424CA104G		7315	"M" Option	N/A	
88 x 24 x 30	370	SPC8824CA104W		7203	SPC8824CA104G		7203	"M" Option	N/A	
<b>4 Drawer</b>										
71 x 24 x 30	285	SPC7124CA104W		4943	SPC7124CA104G		4943	"M" Option	N/A	
59 x 24 x 30	245	SPC5924CA104W		4717	SPC5924CA104G		4717	"M" Option	N/A	
<b>2 Drawer</b>										
36 x 24 x 30	150	SPC3624CA104W		2230	SPC3624CA104G		2230	"M" Option	N/A	
30 x 24 x 30	130	SPC3024CA104W		2117	SPC3024CA104G		2117	"M" Option	N/A	

**2 SELECT A FINISH**

"W" Veneer	"G" HPL	"M" TFL	
WAC	GAC	-	Amber Cherry
WRC	-	-	Caramel Cherry
WIC	GIC	-	Crimson Cherry
WEC	-	-	Ebony Cherry
WHC	GHC	-	Honey Cherry
WOC	GOC	-	KoKo Cherry
WSC	-	-	Scotch Cherry
WAM	GAM	-	Alabaster Maple
WCM	GCM	-	Clear Maple
WWM	GWM	-	Wheat Maple
WBO	-	-	Blush Oak
WMO	-	-	Mocha Oak
WTO	-	-	Toast Oak
WWO	-	-	Wheat Oak
WEW	GEW	-	Executive Walnut
WRW	GRW	-	Gray Luster Walnut
GWG	-	-	Gunstock Walnut
WJW	-	-	Judicial Walnut
WNW	GNW	-	Natural Walnut
WTW	GTW	-	Studio Teak Walnut
WWP	GWL	-	Designer White

**3 SELECT AN EDGE**



**5 OPTIONS**

- FEET**  
- D8: Delete feet and extend fronts to floor - N/C
- FLUSH CUT**  
- FC-B: Flush Unit Both Sides (Facing) for Ganging - N/C  
- FC-L: Flush Unit Left (Facing) for Ganging - N/C  
- FC-R: Flush Unit Right (Facing) for Ganging - N/C
- OPEN PLAN**  
- OPB: "W" "G" Style - Modify Unit for Open Plan Application - \$195

**4 SELECT HARDWARE**



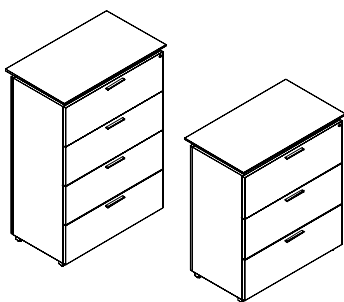

**VERTICAL LATERAL FILE**

**STANDARD FEATURES**

- Anodized aluminum feet
- Anti-tilt/Locking wood drawers
- Full extension drawers - locking
- Soft close suspension drawer(s)

**NOTES**

- Unit not designed for open plan use. Select OPB Option for Open Plan application

[CLICK HERE TO VIEW PRODUCT INDEX](#)

**1 SELECT A STYLE**

DIMENSIONS		STYLE NUMBER	LIST PRICE	STYLE NUMBER	LIST PRICE	STYLE NUMBER	LIST PRICE
W" x D" x H"	WGT	"W" Veneer Veneer Top Veneer Chassis		"G" HPL High Pressure Laminate Top Veneer Chassis		"M" TFL Thermally Fused Laminate Top Thermally Fused Laminate Chassis	
<b>4 Drawer</b>							
36 x 24 x 52	240	SPC3624FI111W	3247	SPC3624FI111G	3247	"M" Option N/A	
30 x 24 x 52	215	SPC3024FI111W	3134	SPC3024FI111G	3134	"M" Option N/A	
<b>3 Drawer</b>							
36 x 24 x 42	195	SPC3624FI112W	2682	SPC3624FI112G	2682	"M" Option N/A	
30 x 24 x 42	175	SPC3024FI112W	2569	SPC3024FI112G	2569	"M" Option N/A	

**2 SELECT A FINISH**

"W" Veneer	"G" HPL	"M" TFL	
WAC	GAC	-	Amber Cherry
WRC	-	-	Caramel Cherry
WIC	GIC	-	Crimson Cherry
WEC	-	-	Ebony Cherry
WHC	GHC	-	Honey Cherry
WOC	GOC	-	KoKo Cherry
WSC	-	-	Scotch Cherry
WAM	GAM	-	Alabaster Maple
WCM	GCM	-	Clear Maple
WWM	GWM	-	Wheat Maple
WBO	-	-	Blush Oak
WMO	-	-	Mocha Oak
WTO	-	-	Toast Oak
WWO	-	-	Wheat Oak
WEW	GEW	-	Executive Walnut
WRW	GRW	-	Gray Luster Walnut
GWG	-	-	Gunstock Walnut
WJW	-	-	Judicial Walnut
WNW	GNW	-	Natural Walnut
WTW	GTW	-	Studio Teak Walnut
WWP	GWL	-	Designer White

**3 SELECT AN EDGE**



**5 OPTIONS**

- FEET**
- D8: Delete feet and extend fronts to floor - N/C
- FLUSH CUT**
- FC-B: Flush Unit Both Sides (Facing) for Ganging - N/C
  - FC-L: Flush Unit Left (Facing) for Ganging - N/C
  - FC-R: Flush Unit Right (Facing) for Ganging - N/C
- OPEN PLAN**
- OPB: "W" "G" Style - Modify Unit for Open Plan Application - \$195

**4 SELECT HARDWARE**

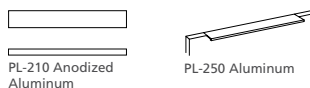



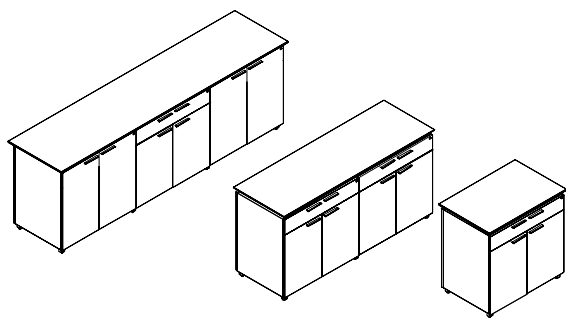

**BUFFET**

**STANDARD FEATURES**

- Adjustable black shelf behind each door section
- Anodized aluminum feet
- Full extension drawers - locking
- Soft close suspension drawer(s)
- Top profile shaped 4 sides
- Utility drawer w/ felt liner

**NOTES**

- Unit not designed for open plan use. Select OPB Option for Open Plan application

[CLICK HERE TO VIEW PRODUCT INDEX](#)

**1 SELECT A STYLE**

DIMENSIONS		STYLE NUMBER	LIST PRICE	STYLE NUMBER	LIST PRICE	STYLE NUMBER	LIST PRICE
W" x D" x H"	WGT	"W" Veneer Top Veneer Chassis		"G" High Pressure Laminate Top Veneer Chassis		"M" Thermally Fused Laminate Top Thermally Fused Laminate Chassis	
71 x 24 x 36	250	SPC7124CA126W	4491	SPC7124CA126G	4491	"M" Option N/A	
36 x 24 x 36	120	SPC3624CA126W	2466	SPC3624CA126G	2466	"M" Option N/A	

**2 SELECT A FINISH**

"W" Veneer	"G" HPL	"M" TFL	
WAC	GAC	-	Amber Cherry
WRC	-	-	Caramel Cherry
WIC	GIC	-	Crimson Cherry
WEC	-	-	Ebony Cherry
WHC	GHC	-	Honey Cherry
WOC	GOC	-	KoKo Cherry
WSC	-	-	Scotch Cherry
WAM	GAM	-	Alabaster Maple
WCM	GCM	-	Clear Maple
WWM	GWM	-	Wheat Maple
WBO	-	-	Blush Oak
WMO	-	-	Mocha Oak
WTO	-	-	Toast Oak
WWO	-	-	Wheat Oak
WEW	GEW	-	Executive Walnut
WRW	GRW	-	Gray Luster Walnut
GWG	-	-	Gunstock Walnut
WJW	-	-	Judicial Walnut
WNW	GNW	-	Natural Walnut
WTW	GTW	-	Studio Teak Walnut
WWP	GWL	-	Designer White

**3 SELECT AN EDGE**



**4 SELECT HARDWARE**

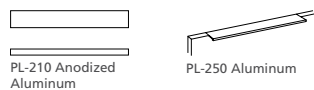

**5 OPTIONS**

- DOOR**
- D2: Door Lock - \$95 per Door Set
  - D6A: "W"/"G" Styles - Delete Doors and replace black laminate shelf with finished shelf - n/c
  - D9SC: Soft Close Door Hinges - \$15 per Door
- FEET**
- D8: Delete feet and extend fronts to floor - N/C
- FLUSH CUT**
- FC-B: Flush Unit Both Sides (Facing) for Ganging - N/C
  - FC-L: Flush Unit Left (Facing) for Ganging - N/C
  - FC-R: Flush Unit Right (Facing) for Ganging - N/C
- GROMMETS (VERTICAL SURFACE)**
- Standard Location - \$45 ea.
  - Black Plastic Vertical Surface: TM50-C (Bottom Center)
  - Non-Standard Location - \$90 ea.
  - Black Plastic Vertical Surface: TM50-NS
- OPEN PLAN**
- OPB: "W" "G" Style - Modify Unit for Open Plan Application - \$195
- REFRIGERATOR**
- Specify Location:
- REF-01: Modify storage for fridge (open back, water retention mat) - \$195

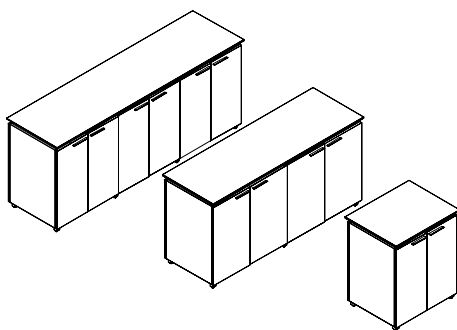

**CONFERENCE STORAGE**

**STANDARD FEATURES**

- Adjustable black shelf behind each door section
- Anodized aluminum feet
- Top profile shaped 4 sides

**NOTES**

- Unit not designed for open plan use. Select OPB Option for Open Plan application

[CLICK HERE TO VIEW PRODUCT INDEX](#)

**1 SELECT A STYLE**

DIMENSIONS		STYLE NUMBER		LIST PRICE	STYLE NUMBER		LIST PRICE	STYLE NUMBER		LIST PRICE
W" x D" x H"	WGT	"W" Veneer	Veneer Top Veneer Chassis		"G" HPL	High Pressure Laminate Top Veneer Chassis		"M" TFL	Thermally Fused Laminate Top Thermally Fused Laminate Chassis	
<b>Triple Storage</b>										
94 x 24 x 36	330	SPC9424CA124W		5748	SPC9424CA124G		5748	"M" Option	N/A	
88 x 24 x 36	310	SPC8824CA124W		5667	SPC8824CA124G		5667	"M" Option	N/A	
<b>Double Storage</b>										
71 x 24 x 36	260	SPC7124CA124W		4377	SPC7124CA124G		4377	"M" Option	N/A	
<b>Single Storage</b>										
36 x 24 x 36	130	SPC3624CA124W		2230	SPC3624CA124G		2230	"M" Option	N/A	
30 x 24 x 36	115	SPC3024CA124W		2174	SPC3024CA124G		2174	"M" Option	N/A	

**2 SELECT A FINISH**

"W" Veneer	"G" HPL	"M" TFL	
WAC	GAC	-	Amber Cherry
WRC	-	-	Caramel Cherry
WIC	GIC	-	Crimson Cherry
WEC	-	-	Ebony Cherry
WHC	GHC	-	Honey Cherry
WOC	GOC	-	KoKo Cherry
WSC	-	-	Scotch Cherry
WAM	GAM	-	Alabaster Maple
WCM	GCM	-	Clear Maple
WWM	GWM	-	Wheat Maple
WBO	-	-	Blush Oak
WMO	-	-	Mocha Oak
WTO	-	-	Toast Oak
WWO	-	-	Wheat Oak
WEW	GEW	-	Executive Walnut
WRW	GRW	-	Gray Luster Walnut
GWG	-	-	Gunstock Walnut
WJW	-	-	Judicial Walnut
WNW	GNW	-	Natural Walnut
WTW	GTW	-	Studio Teak Walnut
WWP	GWL	-	Designer White

**3 SELECT AN EDGE**



**4 SELECT HARDWARE**

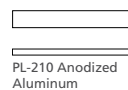

**5 OPTIONS**

- DOOR**
- D2: Door Lock - \$95 per Door Set
  - D6A: "W"/"G" Styles - Delete Doors and replace black laminate shelf with finished shelf - n/c
  - D95C: Soft Close Door Hinges - \$15 per Door
- FEET**
- D8: Delete feet and extend fronts to floor - N/C
- FLUSH CUT**
- FC-B: Flush Unit Both Sides (Facing) for Ganging - N/C
  - FC-L: Flush Unit Left (Facing) for Ganging - N/C
  - FC-R: Flush Unit Right (Facing) for Ganging - N/C
- GROMMETS (STANDARD LOCATION)**
- Specify Color and Location (Right/Left/Center) - \$45 ea.
- Black: TM30-R (Right), TM30-L (Left), TM30-C (Center)
  - Silver: TM31-R (Right), TM31-L (Left), TM31-C (Center)
- GROMMETS (NON-STANDARD LOCATION)**
- Provide drawing w/ Grommet Location and Specify Color - \$90 ea.
- Black: TM30-NS
  - Silver: TM31-NS
- GROMMETS (VERTICAL SURFACE)**
- Standard Location - \$45 ea.
- Black Plastic Vertical Surface: TM50-C (Bottom Center)
  - Non-Standard Location - \$90 ea.
  - Black Plastic Vertical Surface: TM50-NS
- OPEN PLAN**
- OPB: "W" "G" Style - Modify Unit for Open Plan Application - \$195
- REFRIGERATOR**
- Specify Location:
- REF-01: Modify storage for fridge (open back, water retention mat) - \$195

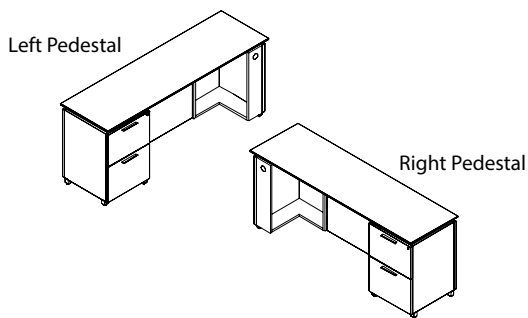

**FILE/FILE**

**STANDARD FEATURES**

- Anodized aluminum feet
- Fixed full wood modesty
- Full extension drawers - locking
- Hookup hardware
- Soft close suspension drawer(s)
- Top profile shaped 4 sides

- Unit not designed for open plan use. Select OPB Option for Open Plan application

**NOTES**

- If unit is specified as freestanding, grommet in end panel will be visible

[CLICK HERE TO VIEW PRODUCT INDEX](#)

**1 SELECT A STYLE**

DIMENSIONS		STYLE NUMBER	LIST PRICE	STYLE NUMBER	LIST PRICE	STYLE NUMBER	LIST PRICE
W" x D" x H"	WGT	"W" Veneer Top Veneer Chassis		"G" HPL High Pressure Laminate Top Veneer Chassis		"M" TFL Thermally Fused Laminate Top Thermally Fused Laminate Chassis	
<b>Left Pedestal (Left Hookup)</b>							
88 x 24 x 30	200	SPC8824CA086W	3924	SPC8824CA086G	3924	"M" Option N/A	
84 x 24 x 30	195	SPC8424CA086W	3848	SPC8424CA086G	3848	"M" Option N/A	
71 x 24 x 30	185	SPC7124CA086W	3072	SPC7124CA086G	3072	"M" Option N/A	
65 x 24 x 30	155	SPC6524CA086W	2959	SPC6524CA086G	2959	"M" Option N/A	
<b>Right Pedestal (Right Hookup)</b>							
88 x 24 x 30	200	SPC8824CA087W	3924	SPC8824CA087G	3924	"M" Option N/A	
84 x 24 x 30	195	SPC8424CA087W	3848	SPC8424CA087G	3848	"M" Option N/A	
71 x 24 x 30	185	SPC7124CA087W	3072	SPC7124CA087G	3072	"M" Option N/A	
65 x 24 x 30	155	SPC6524CA087W	2959	SPC6524CA087G	2959	"M" Option N/A	

**2 SELECT A FINISH**

"W" Veneer	"G" HPL	"M" TFL	
WAC	GAC	-	Amber Cherry
WRC	-	-	Caramel Cherry
WIC	GIC	-	Crimson Cherry
WEC	-	-	Ebony Cherry
WHC	GHC	-	Honey Cherry
WOC	GOC	-	KoKo Cherry
WSC	-	-	Scotch Cherry
WAM	GAM	-	Alabaster Maple
WCM	GCM	-	Clear Maple
WWM	GWM	-	Wheat Maple
WBO	-	-	Blush Oak
WMO	-	-	Mocha Oak
WTO	-	-	Toast Oak
WWO	-	-	Wheat Oak
WEW	GEW	-	Executive Walnut
WRW	GRW	-	Gray Luster Walnut
GWG	-	-	Gunstock Walnut
WJW	-	-	Judicial Walnut
WNW	GNW	-	Natural Walnut
WTW	GTW	-	Studio Teak Walnut
WWP	GWL	-	Designer White

**3 SELECT AN EDGE**



Undercut Bevel

**4 SELECT HARDWARE**

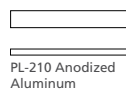

PL-210 Anodized Aluminum



PL-250 Aluminum

**5 OPTIONS**

**ACCESSORIES**

- K1: Center Drawer - \$275
- K28: Articulating Keyboard w/ Mouse - \$375

**DRAWER**

- P6: Modify File/File to Box/Box/File - \$50 per pedestal
- P40W: "W" extra Box/Box/File or File/File to kneespace - \$875

**FLUSH CUT**

- FC-B: Flush Unit Both Sides (Facing) for Ganging - N/C
- FC-L: Flush Unit Left (Facing) for Ganging - N/C
- FC-R: Flush Unit Right (Facing) for Ganging - N/C

**FEET**

- D8: Delete feet and extend fronts to floor - N/C

**GROMMETS (STANDARD LOCATION)**

- Specify Color - \$45 ea.
- Black: TM30-C (Center)
- Silver: TM31-C (Center)

**GROMMETS (NON-STANDARD LOCATION)**

- Provide drawing w/ Grommet Location and Specify Color - \$90 ea.
- Black: TM30-NS
- Silver: TM31-NS

**MODESTY**

- M34T: "W" "G" Style Drop Door Tech Modesty - \$125
- M37P: Partial Height Modesty - \$95
- M51: Open Back Modesty with Wire Mgmt Rail - Deduct \$95

**OPEN PLAN**

- OPB: "W" "G" Style - Modify Unit for Open Plan Application - \$195

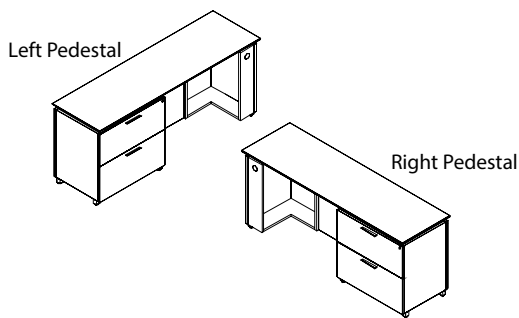

**LATERAL FILE**

**STANDARD FEATURES**

- Anodized aluminum feet
- Fixed full wood modesty
- Full extension drawers - locking
- Hookup hardware
- Soft close suspension drawer(s)
- Top profile shaped 4 sides

- end panel will be visible
- Keyboard not available on 71" & 65" units
- Unit not designed for open plan use. Select OPB Option for Open Plan application

**NOTES**

- File Size 35"W on 88" / 94" Credenzas
- If unit is specified as freestanding, grommet in

[CLICK HERE TO VIEW PRODUCT INDEX](#)

**1 SELECT A STYLE**

DIMENSIONS		STYLE NUMBER	LIST PRICE	STYLE NUMBER	LIST PRICE	STYLE NUMBER	LIST PRICE
W" x D" x H"	WGT	"W" Veneer Top Veneer Chassis		"G" High Pressure Laminate Top Veneer Chassis		"M" Thermally Fused Laminate Top Thermally Fused Laminate Chassis	
<b>Left Pedestal (Left Hookup)</b>							
94 x 24 x 30	250	SPC9424CA066W	4310	SPC9424CA066G	4310	"M" Option N/A	
88 x 24 x 30	240	SPC8824CA066W	4197	SPC8824CA066G	4197	"M" Option N/A	
84 x 24 x 30	235	SPC8424CA066W	4121	SPC8424CA066G	4121	"M" Option N/A	
71 x 24 x 30	220	SPC7124CA066W	3504	SPC7124CA066G	3504	"M" Option N/A	
65 x 24 x 30	205	SPC6524CA066W	3391	SPC6524CA066G	3391	"M" Option N/A	
<b>Right Pedestal (Right Hookup)</b>							
94 x 24 x 30	250	SPC9424CA067W	4310	SPC9424CA067G	4310	"M" Option N/A	
88 x 24 x 30	240	SPC8824CA067W	4197	SPC8824CA067G	4197	"M" Option N/A	
84 x 24 x 30	235	SPC8424CA067W	4121	SPC8424CA067G	4121	"M" Option N/A	
71 x 24 x 30	220	SPC7124CA067W	3504	SPC7124CA067G	3504	"M" Option N/A	
65 x 24 x 30	205	SPC6524CA067W	3391	SPC6524CA067G	3391	"M" Option N/A	

**2 SELECT A FINISH**

"W" Veneer	"G" HPL	"M" TFL	
WAC	GAC	-	Amber Cherry
WRC	-	-	Caramel Cherry
WIC	GIC	-	Crimson Cherry
WEC	-	-	Ebony Cherry
WHC	GHC	-	Honey Cherry
WOC	GOC	-	KoKo Cherry
WSC	-	-	Scotch Cherry
WAM	GAM	-	Alabaster Maple
WCM	GCM	-	Clear Maple
WWM	GWM	-	Wheat Maple
WBO	-	-	Blush Oak
WMO	-	-	Mocha Oak
WTO	-	-	Toast Oak
WWO	-	-	Wheat Oak
WEW	GEW	-	Executive Walnut
WRW	GRW	-	Gray Luster Walnut
WGW	-	-	Gunstock Walnut
WJW	-	-	Judicial Walnut
WNW	GNW	-	Natural Walnut
WTW	GTW	-	Studio Teak Walnut
WWP	GWL	-	Designer White

**3 SELECT AN EDGE**



Undercut Bevel

**4 SELECT HARDWARE**

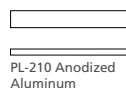

PL-210 Anodized Aluminum



PL-250 Aluminum

**5 OPTIONS**

**ACCESSORIES**

- K1: Center Drawer - \$275
- K28: Articulating Keyboard w/ Mouse - \$375

**DRAWER**

- P40W: "W" extra Box/Box/File or File/File to kneespace - \$875
- N/A on 65"

**FLUSH CUT**

- FC-B: Flush Unit Both Sides (Facing) for Ganging - N/C
- FC-L: Flush Unit Left (Facing) for Ganging - N/C
- FC-R: Flush Unit Right(Facing) for Ganging - N/C

**FEET**

- D8: Delete feet and extend fronts to floor - N/C

**GROMMETS (STANDARD LOCATION)**

- Specify Color - \$45 ea.
- Black: TM30-C (Center)
- Silver: TM31-C (Center)

**GROMMETS (NON-STANDARD LOCATION)**

- Provide drawing w/ Grommet Location and Specify Color - \$90 ea.
- Black: TM30-NS
- Silver: TM31-NS

**MODESTY**

- M34T: "W" "G" Style Drop Door Tech Modesty - \$125
- M37P: Partial Height Modesty - \$95
- M51: Open Back Modesty with Wire Mgmt Rail - Deduct \$95

**OPEN PLAN**

- OPB: "W" "G" Style - Modify Unit for Open Plan Application - \$195

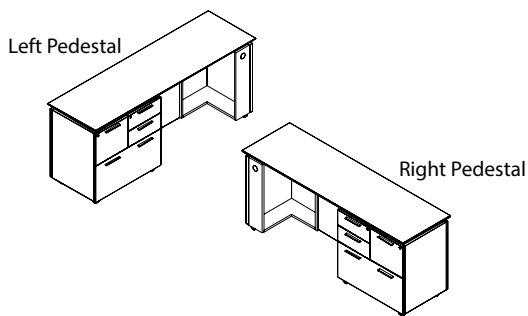

**BOX / BOX / FILE / LATERAL (MULTI-FILE)**

**STANDARD FEATURES**

- Anodized aluminum feet
- Fixed full wood modesty
- Full extension drawers - locking
- Hookup hardware
- Soft close suspension drawer(s)
- Top profile shaped 4 sides

OPB Option for Open Plan application

**NOTES**

- Keyboard not available on 71" & 65" units
- Unit not designed for open plan use. Select

[CLICK HERE TO VIEW PRODUCT INDEX](#)

**1 SELECT A STYLE**

DIMENSIONS		STYLE NUMBER	LIST PRICE	STYLE NUMBER	LIST PRICE	STYLE NUMBER	LIST PRICE
W" x D" x H"	WGT	"W" Veneer Top Veneer Chassis		"G" High Pressure Laminate Top Veneer Chassis		"M" Thermally Fused Laminate Top Thermally Fused Laminate Chassis	
<b>Left Pedestal (Left Hookup)</b>							
94 x 24 x 30	250	SPC9424CA667W	4536	SPC9424CA667G	4536	"M" Option N/A	
88 x 24 x 30	240	SPC8824CA667W	4423	SPC8824CA667G	4423	"M" Option N/A	
84 x 24 x 30	235	SPC8424CA667W	4347	SPC8424CA667G	4347	"M" Option N/A	
71 x 24 x 30	220	SPC7124CA667W	3730	SPC7124CA667G	3730	"M" Option N/A	
65 x 24 x 30	205	SPC6524CA667W	3617	SPC6524CA667G	3617	"M" Option N/A	
<b>Right Pedestal (Right Hookup)</b>							
94 x 24 x 30	250	SPC9424CA668W	4536	SPC9424CA668G	4536	"M" Option N/A	
88 x 24 x 30	240	SPC8824CA668W	4423	SPC8824CA668G	4423	"M" Option N/A	
84 x 24 x 30	235	SPC8424CA668W	4347	SPC8424CA668G	4347	"M" Option N/A	
71 x 24 x 30	220	SPC7124CA668W	3730	SPC7124CA668G	3730	"M" Option N/A	
65 x 24 x 30	205	SPC6524CA668W	3617	SPC6524CA668G	3617	"M" Option N/A	

**2 SELECT A FINISH**

"W" Veneer	"G" HPL	"M" TFL	
WAC	GAC	-	Amber Cherry
WRC	-	-	Caramel Cherry
WIC	GIC	-	Crimson Cherry
WEC	-	-	Ebony Cherry
WHC	GHC	-	Honey Cherry
WOC	GOC	-	KoKo Cherry
WSC	-	-	Scotch Cherry
WAM	GAM	-	Alabaster Maple
WCM	GCM	-	Clear Maple
WWM	GWM	-	Wheat Maple
WBO	-	-	Blush Oak
WMO	-	-	Mocha Oak
WTO	-	-	Toast Oak
WWO	-	-	Wheat Oak
WEW	GEW	-	Executive Walnut
WRW	GRW	-	Gray Luster Walnut
WGW	-	-	Gunstock Walnut
WJW	-	-	Judicial Walnut
WNW	GNW	-	Natural Walnut
WTW	GTW	-	Studio Teak Walnut
WWP	GWL	-	Designer White

**3 SELECT AN EDGE**



Undercut Bevel

**4 SELECT HARDWARE**

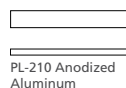

PL-210 Anodized Aluminum



PL-250 Aluminum

**5 OPTIONS**

**ACCESSORIES**

- K1: Center Drawer - \$275
- K28: Articulating Keyboard w/ Mouse - \$375

**DRAWER**

- P40W: "W" extra Box/Box/File or File/File to kneespace - \$875
- N/A on 65"

**FEET**

- D8: Delete feet and extend fronts to floor - N/C

**FLUSH CUT**

- FC-B: Flush Unit Both Sides (Facing) for Ganging - N/C
- FC-L: Flush Unit Left (Facing) for Ganging - N/C
- FC-R: Flush Unit Right (Facing) for Ganging - N/C

**GROMMETS (STANDARD LOCATION)**

- Specify Color - \$45 ea.
- Black: TM30-C (Center)
- Silver: TM31-C (Center)

**GROMMETS (NON-STANDARD LOCATION)**

- Provide drawing w/ Grommet Location and Specify Color - \$90 ea.
- Black: TM30-NS
- Silver: TM31-NS

**MODESTY**

- Full Modesty:
- M34T: "W" "G" Style Drop Door Tech Modesty - \$125
- M37P: Partial Height Modesty - \$95
- M51: Open Back Modesty with Wire Mgmt Rail - Deduct \$95

**OPEN PLAN**

- OPB: "W" "G" Style - Modify Unit for Open Plan Application - \$195

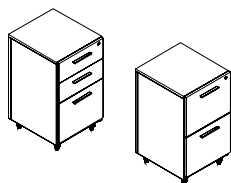

**BOX/BOX/FILE - FILE/FILE**

**STANDARD FEATURES**

- Anti-tip counter weight
- Legal/Letter filing
- Matte silver hub casters/locking
- Soft close suspension drawer(s)

[CLICK HERE TO VIEW PRODUCT INDEX](#)

**1 SELECT A STYLE**

DIMENSIONS		STYLE NUMBER	LIST PRICE	STYLE NUMBER	LIST PRICE	STYLE NUMBER	LIST PRICE
W" x D" x H"	WGT	"W" Veneer Top Veneer Chassis		"G" High Pressure Laminate Top Veneer Chassis		"M" Thermally Fused Laminate Top Thermally Fused Laminate Chassis	
<b>Box/Box/File</b>							
16 x 18 x 27	80	SPC1618PD424W	1675	"G" Option N/A		"M" Option N/A	
<b>File/File</b>							
16 x 18 x 27	80	SPC1618PD425W	1675	"G" Option N/A		"M" Option N/A	

COM 190	COL 210	1 235	2 250	3 265	4 280	5 295	6 310	7 325	8 340	9 355	10 370	11/ L1 385	12 400	13/ L2 430
---------	---------	-------	-------	-------	-------	-------	-------	-------	-------	-------	--------	------------	--------	------------

**2 SELECT A FINISH**

"W" Veneer	"G" HPL	"M" TFL	
WAC	-	-	Amber Cherry
WRC	-	-	Caramel Cherry
WIC	-	-	Crimson Cherry
WEC	-	-	Ebony Cherry
WHC	-	-	Honey Cherry
WOC	-	-	KoKo Cherry
WSC	-	-	Scotch Cherry
WAM	-	-	Alabaster Maple
WCM	-	-	Clear Maple
WWM	-	-	Wheat Maple
WBO	-	-	Blush Oak
WMO	-	-	Mocha Oak
WTO	-	-	Toast Oak
WWO	-	-	Wheat Oak
WEW	-	-	Executive Walnut
WRW	GRW	-	Gray Luster Walnut
GW	-	-	Gunstock Walnut
WJW	-	-	Judicial Walnut
WNW	-	-	Natural Walnut
WTW	-	-	Studio Teak Walnut
WWP	-	-	Designer White

**3 SELECT AN EDGE**

Edge Profile  
Option Not Available

**5 OPTIONS**

CUSHION (SEE PRICING ABOVE BASED ON GRADE)  
- STL-424: Add Cushion

**4 SELECT HARDWARE**

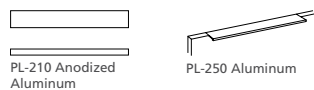

**SINGLE STORAGE OVERHEAD CONSOLE**

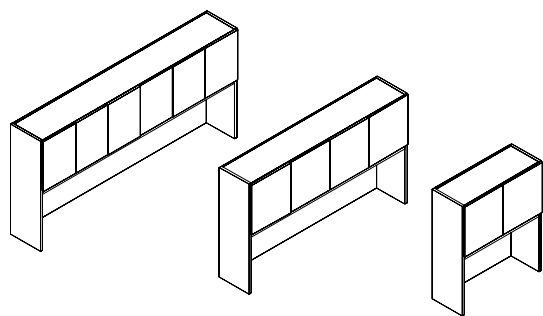

**PANEL DOOR - 6/4/2 DOOR**

**STANDARD FEATURES**

- Finger pull
- Finished top
- Interior cabinet depth 12.5"
- Task light grommet(s)

**NOTES**

- Unit has black back panel and is not designed for Open Plan use. Select OPB Option for Open Plan application

[CLICK HERE TO VIEW PRODUCT INDEX](#)

**1 SELECT A STYLE**

DIMENSIONS		STYLE NUMBER	LIST PRICE	STYLE NUMBER	LIST PRICE	STYLE NUMBER	LIST PRICE
W" x D" x H"	WGT	"W" Veneer Top Veneer Chassis		"G" High Pressure Laminate Top Veneer Chassis		"M" Thermally Fused Laminate Top Thermally Fused Laminate Chassis	
<b>6 Door</b>							
93 x 14 x 42	280	SPC9342OH325W	4341	"G" Option N/A		"M" Option N/A	
87 x 14 x 42	260	SPC8742OH325W	3625	"G" Option N/A		"M" Option N/A	
<b>4 Door</b>							
83 x 14 x 42	240	SPC8342OH325W	3499	"G" Option N/A		"M" Option N/A	
76 x 14 x 42	220	SPC7642OH325W	3388	"G" Option N/A		"M" Option N/A	
70 x 14 x 42	210	SPC7042OH325W	3272	"G" Option N/A		"M" Option N/A	
64 x 14 x 42	190	SPC6442OH325W	3158	"G" Option N/A		"M" Option N/A	
58 x 14 x 42	180	SPC5842OH325W	3091	"G" Option N/A		"M" Option N/A	
<b>2 Door</b>							
35 x 14 x 42	115	SPC3542OH325W	1981	"G" Option N/A		"M" Option N/A	
29 x 14 x 42	100	SPC2942OH325W	1913	"G" Option N/A		"M" Option N/A	

**2 SELECT A FINISH**

"W" Veneer	"G" HPL	"M" TFL	Finish
WAC	-	-	Amber Cherry
WRC	-	-	Caramel Cherry
WIC	-	-	Crimson Cherry
WEC	-	-	Ebony Cherry
WHC	-	-	Honey Cherry
WOC	-	-	KoKo Cherry
WSC	-	-	Scotch Cherry
WAM	-	-	Alabaster Maple
WCM	-	-	Clear Maple
WWM	-	-	Wheat Maple
WBO	-	-	Blush Oak
WMO	-	-	Mocha Oak
WTO	-	-	Toast Oak
WWO	-	-	Wheat Oak
WEW	-	-	Executive Walnut
WRW	GRW	-	Gray Luster Walnut
GWG	-	-	Gunstock Walnut
WJW	-	-	Judicial Walnut
WNW	-	-	Natural Walnut
WTW	-	-	Studio Teak Walnut
WWP	-	-	Designer White

**3 SELECT AN EDGE**

Edge Profile  
Option Not Available

**4 SELECT HARDWARE**

Hardware  
Option Not Available

**5 OPTIONS**

- DOOR**
- D2: Door Lock - \$95 per Door Set
  - D6: Delete Doors - n/c
  - D9SC: Soft Close Door Hinges - \$15 per Door
- GROMMETS (VERTICAL SURFACE)**
- Standard Location - \$45 ea.
- Black Plastic Vertical Surface: TM50-C (Bottom Center)
- Non-Standard Location - \$90 ea.
- Black Plastic Vertical Surface: TM50-NS
- INTERIOR CABINET LIGHTING**
- LEDPK starter kit includes Infeed, 1 Puck Interior Light and the ability to daisy chain up to 6 total Puck Lights
- LEDPK: LED Puck Starter Kit - \$295
  - PK: 1 LED Interior Light - \$125 ea.
- TASK LIGHT**
- LT-LED24: 24" LED Tasklight - \$90
  - LT-LED48: 48" LED Tasklight - \$165
  - LT-LED60: 60" LED Tasklight - \$180
  - LC22: 20" LT-LED Tasklight Linking Cable - \$20
  - LED24: 24" Slim Line Aluminum LED Tasklight - \$315
  - LED48: 48" Slim Line Aluminum LED Tasklight - \$445
  - LED60: 60" Slim Line Aluminum LED Tasklight - \$555
  - DPC: Link multiple tasklights up to 30W of power wattage. Deletes 1 power drive - Deduct \$85 per tasklight
- OPEN PLAN**
- OPB: "W" "G" Style - Modify Unit for Open Plan Application - \$295

**SINGLE STORAGE OVERHEAD CONSOLE**

**MINI-ALUMINUM FRAME FROSTED GLASS - 6/4/2 DOOR**

**STANDARD FEATURES**

- Finished top
- Frosted glass resists finger prints
- Interior cabinet depth 12.5"
- Task light grommet(s)
- Touch latch

**NOTES**

-Unit has black back panel and is not designed for Open Plan use. Select OPB Option for Open Plan application

[CLICK HERE TO VIEW PRODUCT INDEX](#)

**1 SELECT A STYLE**

DIMENSIONS		STYLE NUMBER	LIST PRICE	STYLE NUMBER	LIST PRICE	STYLE NUMBER	LIST PRICE
W" x D" x H"	WGT	"W" Veneer Top Veneer Chassis		"G" HPL High Pressure Laminate Top Veneer Chassis		"M" TFL Thermally Fused Laminate Top Thermally Fused Laminate Chassis	
<b>6 Door</b>							
93 x 14 x 42	280	SPC9342OH321W	5753	"G" Option N/A		"M" Option N/A	
87 x 14 x 42	260	SPC8742OH321W	5046	"G" Option N/A		"M" Option N/A	
<b>4 Door</b>							
83 x 14 x 42	250	SPC8342OH321W	4550	"G" Option N/A		"M" Option N/A	
76 x 14 x 42	235	SPC7642OH321W	4428	"G" Option N/A		"M" Option N/A	
70 x 14 x 42	210	SPC7042OH321W	4220	"G" Option N/A		"M" Option N/A	
64 x 14 x 42	190	SPC6442OH321W	4099	"G" Option N/A		"M" Option N/A	
58 x 14 x 42	180	SPC5842OH321W	4040	"G" Option N/A		"M" Option N/A	
<b>2 Door</b>							
35 x 14 x 42	115	SPC3542OH321W	2448	"G" Option N/A		"M" Option N/A	
29 x 14 x 42	100	SPC2942OH321W	2273	"G" Option N/A		"M" Option N/A	

**2 SELECT A FINISH**

"W" Veneer	"G" HPL	"M" TFL	Finish
WAC	-	-	Amber Cherry
WRC	-	-	Caramel Cherry
WIC	-	-	Crimson Cherry
WEC	-	-	Ebony Cherry
WHC	-	-	Honey Cherry
WOC	-	-	KoKo Cherry
WSC	-	-	Scotch Cherry
WAM	-	-	Alabaster Maple
WCM	-	-	Clear Maple
WWM	-	-	Wheat Maple
WBO	-	-	Blush Oak
WMO	-	-	Mocha Oak
WTO	-	-	Toast Oak
WWO	-	-	Wheat Oak
WEW	-	-	Executive Walnut
WRW	GRW	-	Gray Luster Walnut
GWG	-	-	Gunstock Walnut
WJW	-	-	Judicial Walnut
WNW	-	-	Natural Walnut
WTW	-	-	Studio Teak Walnut
WWP	-	-	Designer White

**3 SELECT AN EDGE**

Edge Profile  
Option Not Available

**4 SELECT HARDWARE**

Hardware  
Option Not Available

**5 OPTIONS**

- DOOR**  
Mini-Frame:  
- D2-40WG: White Glass - \$195 per door  
- D2-G: Door Lock for Glass Doors - \$195 per Door Set  
- D9SC: Soft Close Door Hinges - \$15 per Door
- GROMMETS (VERTICAL SURFACE)**  
Standard Location - \$45 ea.  
- Black Plastic Vertical Surface: TM50-C (Bottom Center)  
Non-Standard Location - \$90 ea.  
- Black Plastic Vertical Surface: TM50-NS
- INTERIOR CABINET LIGHTING**  
LEDPK starter kit includes Infeed, 1 Puck Interior Light and the ability to daisy chain up to 6 total Puck Lights  
- LEDPK: LED Puck Starter Kit - \$295  
- PK: 1 LED Interior Light - \$125 ea.
- TASK LIGHT**  
- LT-LED24: 24" LED Tasklight - \$90  
- LT-LED48: 48" LED Tasklight - \$165  
- LT-LED60: 60" LED Tasklight - \$180  
- LC22: 20" LT-LED Tasklight Linking Cable - \$20  
- LED24: 24" Slim Line Aluminum LED Tasklight - \$315  
- LED48: 48" Slim Line Aluminum LED Tasklight - \$445  
- LED60: 60" Slim Line Aluminum LED Tasklight - \$555  
- DPC: Link multiple tasklights up to 30W of power wattage. Deletes 1 power drive - Deduct \$85 per tasklight
- OPEN PLAN**  
- OPB: "W" "G" Style - Modify Unit for Open Plan Application - \$295



**DOUBLE STORAGE OVERHEAD CONSOLE**

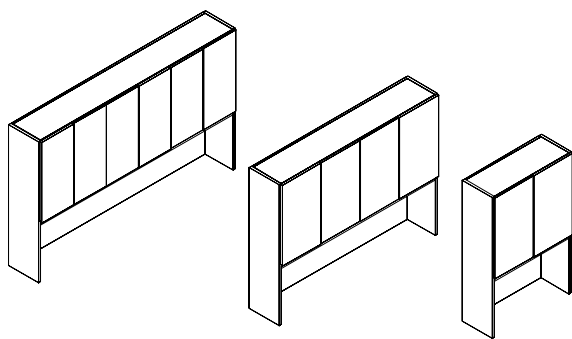

**PANEL DOOR - 6/4/2 DOOR**

**STANDARD FEATURES**

- Black painted top
- Interior shelf depth 12"
- Task light grommet(s)
- Touch latch
- Wood shelves

**NOTES**

-Unit has black back panel and is not designed for Open Plan use. Select OPB Option for Open Plan application

[CLICK HERE TO VIEW PRODUCT INDEX](#)

**1 SELECT A STYLE**

DIMENSIONS		STYLE NUMBER	LIST PRICE	STYLE NUMBER	LIST PRICE	STYLE NUMBER	LIST PRICE
W" x D" x H"	WGT	"W" Veneer Top Veneer Chassis		"G" HPL High Pressure Laminate Top Veneer Chassis		"M" TFL Thermally Fused Laminate Top Thermally Fused Laminate Chassis	
<b>6 Door</b>							
93 x 14 x 54	315	SPC9354OH325W	5508	"G" Option N/A		"M" Option N/A	
87 x 14 x 54	300	SPC8754OH325W	5163	"G" Option N/A		"M" Option N/A	
<b>4 Door</b>							
83 x 14 x 54	290	SPC8354OH325W	4443	"G" Option N/A		"M" Option N/A	
76 x 14 x 54	270	SPC7654OH325W	4205	"G" Option N/A		"M" Option N/A	
70 x 14 x 54	250	SPC7054OH325W	3986	"G" Option N/A		"M" Option N/A	
64 x 14 x 54	230	SPC6454OH325W	3748	"G" Option N/A		"M" Option N/A	
58 x 14 x 54	215	SPC5854OH325W	3684	"G" Option N/A		"M" Option N/A	
<b>2 Door</b>							
35 x 14 x 54	160	SPC3554OH325W	2331	"G" Option N/A		"M" Option N/A	
29 x 14 x 54	150	SPC2954OH325W	2268	"G" Option N/A		"M" Option N/A	

**2 SELECT A FINISH**

"W" Veneer	"G" HPL	"M" TFL	Finish
WAC	-	-	Amber Cherry
WRC	-	-	Caramel Cherry
WIC	-	-	Crimson Cherry
WEC	-	-	Ebony Cherry
WHC	-	-	Honey Cherry
WOC	-	-	KoKo Cherry
WSC	-	-	Scotch Cherry
WAM	-	-	Alabaster Maple
WCM	-	-	Clear Maple
WWM	-	-	Wheat Maple
WBO	-	-	Blush Oak
WMO	-	-	Mocha Oak
WTO	-	-	Toast Oak
WWO	-	-	Wheat Oak
WEW	-	-	Executive Walnut
WRW	GRW	-	Gray Luster Walnut
GW	-	-	Gunstock Walnut
WJW	-	-	Judicial Walnut
WNW	-	-	Natural Walnut
WTW	-	-	Studio Teak Walnut
WWP	-	-	Designer White

**3 SELECT AN EDGE**

Edge Profile  
Option Not Available

**4 SELECT HARDWARE**

Hardware  
Option Not Available

**5 OPTIONS**

- DOOR**
- D2: Door Lock - \$95 per Door Set
  - D6: Delete Doors - n/c
  - D9SC: Soft Close Door Hinges - \$15 per Door
- GROMMETS (VERTICAL SURFACE)**
- Standard Location - \$45 ea.
- Black Plastic Vertical Surface: TM50-C (Bottom Center)
- Non-Standard Location - \$90 ea.
- Black Plastic Vertical Surface: TM50-NS
- INTERIOR CABINET LIGHTING**
- LEDPK starter kit includes Infeed, 1 Puck Interior Light and the ability to daisy chain up to 6 total Puck Lights
- LEDPK: LED Puck Starter Kit - \$295
  - PK: 1 LED Interior Light - \$125 ea.
- TASK LIGHT**
- LT-LED24: 24" LED Tasklight - \$90
  - LT-LED48: 48" LED Tasklight - \$165
  - LT-LED60: 60" LED Tasklight - \$180
  - LC22: 20" LT-LED Tasklight Linking Cable - \$20
  - LED24: 24" Slim Line Aluminum LED Tasklight - \$315
  - LED48: 48" Slim Line Aluminum LED Tasklight - \$445
  - LED60: 60" Slim Line Aluminum LED Tasklight - \$555
  - DPC: Link multiple tasklights up to 30W of power wattage. Deletes 1 power drive - Deduct \$85 per tasklight
- OPEN PLAN**
- OPB: "W" "G" Style - Modify Unit for Open Plan Application - \$295
- SHELVES**
- S714F: Replace Standard Shelf with Heavy Duty Lumber 1" Shelf - \$75 per Shelf ("M" Styles - n/a)

**DOUBLE STORAGE OVERHEAD CONSOLE**

**MINI-ALUMINUM FRAME FROSTED GLASS - 6/4/2 DOOR**

**STANDARD FEATURES**

- Black painted top
- Frosted glass resists finger prints
- Interior shelf depth 12"
- Task light grommet(s)
- Touch latch
- Wood shelves

Plan application

**NOTES**

- Unit has black back panel and is not designed for Open Plan use. Select OPB Option for Open

[CLICK HERE TO VIEW PRODUCT INDEX](#)

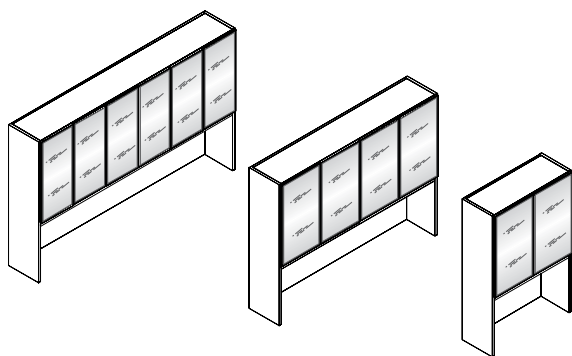

**1 SELECT A STYLE**

DIMENSIONS		STYLE NUMBER	LIST PRICE	STYLE NUMBER	LIST PRICE	STYLE NUMBER	LIST PRICE
W" x D" x H"	WGT	"W" Veneer Top Veneer Chassis		"G" High Pressure Laminate Top Veneer Chassis		"M" Thermally Fused Laminate Top Thermally Fused Laminate Chassis	
<b>6 Door</b>							
87 x 14 x 54	300	SPC8754OH321W	6721	"G" Option N/A		"M" Option N/A	
<b>4 Door</b>							
70 x 14 x 54	250	SPC7054OH321W	5023	"G" Option N/A		"M" Option N/A	
64 x 14 x 54	230	SPC6454OH321W	4789	"G" Option N/A		"M" Option N/A	
58 x 14 x 54	215	SPC5854OH321W	4726	"G" Option N/A		"M" Option N/A	
<b>2 Door</b>							
35 x 14 x 54	160	SPC3554OH321W	2867	"G" Option N/A		"M" Option N/A	
29 x 14 x 54	150	SPC2954OH321W	2658	"G" Option N/A		"M" Option N/A	

**2 SELECT A FINISH**

"W" Veneer	"G" HPL	"M" TFL	Finish
WAC	-	-	Amber Cherry
WRC	-	-	Caramel Cherry
WIC	-	-	Crimson Cherry
WEC	-	-	Ebony Cherry
WHC	-	-	Honey Cherry
WOC	-	-	KoKo Cherry
WSC	-	-	Scotch Cherry
WAM	-	-	Alabaster Maple
WCM	-	-	Clear Maple
WWM	-	-	Wheat Maple
WBO	-	-	Blush Oak
WMO	-	-	Mocha Oak
WTO	-	-	Toast Oak
WWO	-	-	Wheat Oak
WEW	-	-	Executive Walnut
WRW	GRW	-	Gray Luster Walnut
GWG	-	-	Gunstock Walnut
WJW	-	-	Judicial Walnut
WNW	-	-	Natural Walnut
WTW	-	-	Studio Teak Walnut
WWP	-	-	Designer White

**3 SELECT AN EDGE**

Edge Profile  
Option Not Available

**4 SELECT HARDWARE**

Hardware  
Option Not Available

**5 OPTIONS**

- DOOR**  
Mini-Frame:  
 - D2-40WG: White Glass - \$295 per door  
 - D2-G: Door Lock for Glass Doors - \$195 per Door Set  
 - D9SC: Soft Close Door Hinges - \$15 per Door
- GROMMETS (VERTICAL SURFACE)**  
 Standard Location - \$45 ea.  
 - Black Plastic Vertical Surface: TM50-C (Bottom Center)  
 Non-Standard Location - \$90 ea.  
 - Black Plastic Vertical Surface: TM50-NS
- INTERIOR CABINET LIGHTING**  
 LEDPK starter kit includes Infeed, 1 Puck Interior Light and the ability to daisy chain up to 6 total Puck Lights  
 - LEDPK: LED Puck Starter Kit - \$295  
 - PK: 1 LED Interior Light - \$125 ea.
- TASK LIGHT**  
 - LT-LED24: 24" LED Tasklight - \$90  
 - LT-LED48: 48" LED Tasklight - \$165  
 - LT-LED60: 60" LED Tasklight - \$180  
 - LC22: 20" LT-LED Tasklight Linking Cable - \$20  
 - LED24: 24" Slim Line Aluminum LED Tasklight - \$315  
 - LED48: 48" Slim Line Aluminum LED Tasklight - \$445  
 - LED60: 60" Slim Line Aluminum LED Tasklight - \$555  
 - DPC: Link multiple tasklights up to 30W of power wattage. Deletes 1 power drive - Deduct \$85 per tasklight
- OPEN PLAN**  
 - OPB: "W" "G" Style - Modify Unit for Open Plan Application - \$295
- SHELF**  
 - GS14F: Replace Standard Shelves with Glass Shelves - \$85 per Shelf

OVERHEAD TACKBOARDS

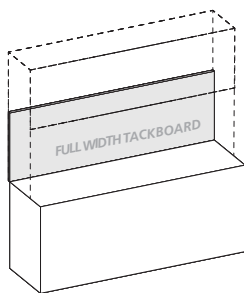

FULL WIDTH TACKBOARDS

STANDARD FEATURES

- Constructed of .5" thick fiberboard
- Fabric is precisely aligned and fitted to the tackboard
- Adhered to the rigid hardboard with staples

PRODUCT WIDTH	PANEL DIMENSION	SKU	COM	1	2	3	4	5	6	7	8	9	10	11/L1	12	13/L2
105"	103 x .5 x 21	FTOC10321	405	525	584	643	702	761	820	879	938	997	1056	1115	1174	1292
99"	97 x .5 x 21	FTOC9721	384	495	550	605	660	715	770	825	880	935	990	1045	1100	1210
93"	91 x .5 x 21	FTOC9121	364	465	516	567	618	669	720	771	822	873	924	975	1,026	1,128
87"	85 x .5 x 21	FTOC8521	344	435	483	531	579	627	675	723	771	819	867	915	963	1,059
83"	81 x .5 x 21	FTOC8121	323	415	461	507	553	599	645	691	737	783	829	875	921	1,013
76"	74 x .5 x 21	FTOC7421	297	380	423	466	509	552	595	638	681	724	767	810	853	939
70"	68 x .5 x 21	FTOC6821	271	350	390	430	470	510	550	590	630	670	710	750	790	870
64"	62 x .5 x 21	FTOC6221	246	320	356	392	428	464	500	536	572	608	644	680	716	788
58"	56 x .5 x 21	FTOC5621	225	290	322	354	386	418	450	482	514	546	578	610	642	706
47"	45 x .5 x 21	FTOC4521	180	235	262	289	316	343	370	397	424	451	478	505	532	586
35"	33 x .5 x 21	FTOC3321	136	175	195	215	235	255	275	295	315	335	355	375	395	435
29"	27 x .5 x 21	FTOC2721	108	145	162	179	196	213	230	247	264	281	298	315	332	366

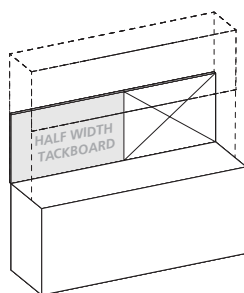

OVERHEAD TACKBOARDS

HALF WIDTH TACKBOARDS

STANDARD FEATURES

- Constructed of .5" thick fiberboard
- Fabric is precisely aligned and fitted to the tackboard
- Adhered to the rigid hardboard with staples

Notes

- Half width tackboards can be specified and combined with Marker Board, Slat Wall and Glass Board options. See "Half Width" items under product width.
- Must specify Right or left facing tackboard

PRODUCT WIDTH	PANEL DIMENSION	SKU	COM	1	2	3	4	5	6	7	8	9	10	11/L1	12	13/L2
105 Half Width	51.5 x .875 x 21	FTOC5121	203	263	292	322	351	381	410	440	469	499	528	558	587	646
99 Half Width	48.5 x .875 x 21	FTOC4821	192	248	275	303	330	358	385	413	440	468	495	523	550	605
93 Half Width	45.5 x .875 x 21	FTOC4521	182	233	258	284	309	335	360	386	411	437	462	488	513	564
87 Half Width	42.5 x .875 x 21	FTOC4221	172	218	242	266	290	314	338	362	386	410	434	458	482	530
83 Half Width	40.5 x .875 x 21	FTOC4021	162	208	231	254	277	300	323	346	369	392	415	438	461	507
76 Half Width	37 x .875 x 21	FTOC3721	149	190	212	233	255	276	298	319	341	362	384	405	427	470
70 Half Width	34 x .875 x 21	FTOC3421	136	175	195	215	235	255	275	295	315	335	355	375	395	435
64 Half Width	31 x .875 x 21	FTOC3121	123	160	178	196	214	232	250	268	286	304	322	340	358	394

**OVERHEAD DRY MARKER BOARD**

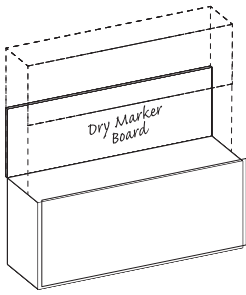

**FULL WIDTH DRY MARKER BOARD**

**STANDARD FEATURES**

- Dry marker panel has edge trim molding
- Standard magnetic surface

PRODUCT WIDTH	PANEL DIMENSION	SKU	LIST
105"	103 x .5 x 21	DMOC10321	1236
99"	97 x .5 x 21	DMOC9721	1164
93	91 x .75 x 21	DMOC9121	1092
87	85 x .75 x 21	DMOC8521	1020
83	81 x .75 x 21	DMOC8121	972
76	74 x .75 x 21	DMOC7421	888
70	68 x .75 x 21	DMOC6821	816
64	62 x .75 x 21	DMOC6221	744
58	56 x .75 x 21	DMOC5621	672
47	45 x .75 x 21	DMOC4521	564
35	33 x .75 x 21	DMOC3321	420
29	27 x .75 x 21	DMOC2721	324

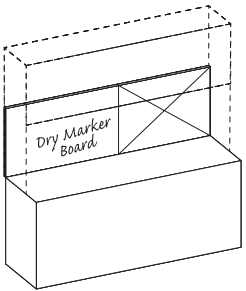

**OVERHEAD DRY MARKER BOARD**

**HALF WIDTH DRY MARKER BOARD**

**STANDARD FEATURES**

- Dry marker panel has edge trim molding
- Standard magnetic surface

**Notes**

- Half width dry marker boards can be specified and combined with a Tackboard, Veneer Panel, Slat Wall or Glass Board. See "Half Width" items under product width.
- Must specify Right or left facing dry marker board

PRODUCT WIDTH	PANEL DIMENSION	SKU	LIST
105 Half Width	51.5 x .875 x 21	DMOC5121	630
99 Half Width	48.5 x .875 x 21	DMOC4821	594
93 Half Width	45.5 x .75 x 21	DMOC4521	534
87 Half Width	42.5 x .75 x 21	DMOC4221	498
83 Half Width	40.5 x .75 x 21	DMOC4021	474
76 Half Width	37 x .75 x 21	DMOC3721	432
70 Half Width	34 x .75 x 21	DMOC3421	420
64 Half Width	31 x .75 x 21	DMOC3121	360

OVERHEAD GLASSBOARD

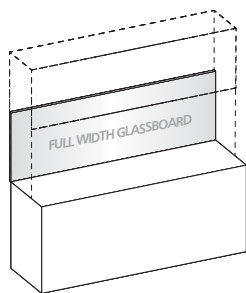

**FULL WIDTH GLASSBOARD**

**STANDARD FEATURES**

- 4 mm tempered glass
- Use glass cleaner or alcohol to clean
- Standard dry erase markers may be used
- Earth magnets are required to hold items securely in place
- Hung with Z-Strip mounting system

PRODUCT WIDTH	PANEL DIMENSION	SKU	LIST
105"	103 x .5 x 21	GBOC10321	2570
99"	97 x .5 x 21	GBOC9924	2430
93	91 x .75 x 21	GBOC9121	2290
87	85 x .75 x 21	GBOC8521	2150
83	81 x .75 x 21	GBOC8121	2056
76	74 x .75 x 21	GBOC7421	1893
70	68 x .75 x 21	GBOC6821	1752
64	62 x .75 x 21	GBOC6221	1612
58	56 x .75 x 21	GBOC5621	1472
47	45 x .75 x 21	GBOC4521	1215
35	33 x .75 x 21	GBOC3321	935
29	27 x .75 x 21	GBOC2721	794

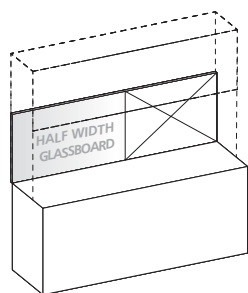

OVERHEAD GLASSBOARD

**HALF WIDTH GLASSBOARD**

**STANDARD FEATURES**

- 4 mm tempered glass
- Use glass cleaner or alcohol to clean
- Standard dry erase markers may be used
- Earth magnets are required to hold items securely in place
- Hung with Z-Strip mounting system

**Notes**

- Half width glassboards can be specified and combined with a Tackboard, Veneer panel, Marker Board or Slat Wall. See "Half Width" items under product width.
- Must specify Right or left facing glassboard

PRODUCT WIDTH	PANEL DIMENSION	SKU	LIST
105 Half Width	51.5 x .875 x 21	GBOC5121	1343
99 Half Width	48.5 x .875 x 21	GBOC4821	1273
93 Half Width	45.5 x .75 x 21	GBOC4521	1203
87 Half Width	42.5 x .75 x 21	GBOC4221	1133
83 Half Width	40.5 x .75 x 21	GBOC4021	1086
76 Half Width	37 x .75 x 21	GBOC3721	947
70 Half Width	34 x .75 x 21	GBOC3421	935
64 Half Width	31 x .75 x 21	GBOC3121	864

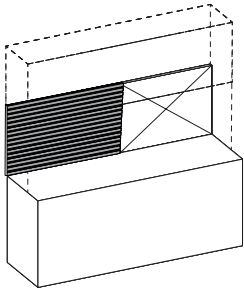

**HALF WIDTH SLAT WALL**

**STANDARD FEATURES**

- Available in silver or black
- For use on 42"/43" height consoles
- Specify Left or Right Position

**Notes**

- Half width slat walls can be specified and combined with a Tackboard, Veneer panel, Marker Board or Glassboard. See "Half Width" items under product width.
- Must specify Right or left facing slat wall

PRODUCT WIDTH	PANEL DIMENSION	SKU	LIST
105 Half Width	51.5 x .875 x 21	SWOC5121	525
99 Half Width	48.5 x .875 x 21	SWOC4821	495
93 Half Width	45.5 x .75 x 21	SWOC4521	445
87 Half Width	42.5 x .75 x 21	SWOC4221	415
83 Half Width	40.5 x .75 x 21	SWOC4021	395
76 Half Width	37 x .75 x 21	SWOC3721	360
70 Half Width	34 x .75 x 21	SWOC3421	330
64 Half Width	31 x .75 x 21	SWOC3121	300

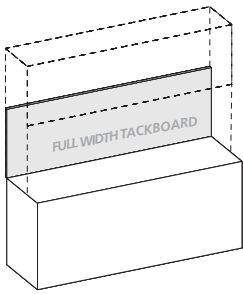

[CLICK HERE TO VIEW PRODUCT INDEX](#)

**1 SELECT A STYLE**

DIMENSIONS		STYLE NUMBER	LIST PRICE	STYLE NUMBER	LIST PRICE	STYLE NUMBER	LIST PRICE
W" x D" x H"	WGT						

**2 SELECT A FINISH**

**3 SELECT AN EDGE**

**5 OPTIONS**

**4 SELECT HARDWARE**

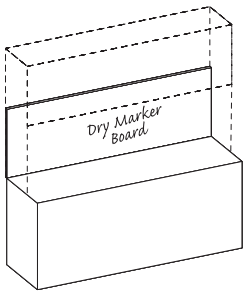

[CLICK HERE TO VIEW PRODUCT INDEX](#)

**1 SELECT A STYLE**

DIMENSIONS		STYLE NUMBER	LIST PRICE	STYLE NUMBER	LIST PRICE	STYLE NUMBER	LIST PRICE
W" x D" x H"	WGT						

**2 SELECT A FINISH**

**3 SELECT AN EDGE**

**5 OPTIONS**

**4 SELECT HARDWARE**



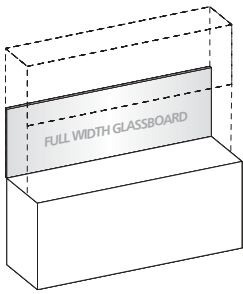

[CLICK HERE TO VIEW PRODUCT INDEX](#)

**1 SELECT A STYLE**

DIMENSIONS		STYLE NUMBER	LIST PRICE	STYLE NUMBER	LIST PRICE	STYLE NUMBER	LIST PRICE
W" x D" x H"	WGT						

**2 SELECT A FINISH** | **3 SELECT AN EDGE** | **5 OPTIONS**

**4 SELECT HARDWARE**

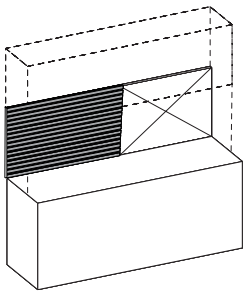

[CLICK HERE TO VIEW PRODUCT INDEX](#)

**1 SELECT A STYLE**

DIMENSIONS		STYLE NUMBER	LIST PRICE	STYLE NUMBER	LIST PRICE	STYLE NUMBER	LIST PRICE
W" x D" x H"	WGT						

**2 SELECT A FINISH**

**3 SELECT AN EDGE**

**5 OPTIONS**

**4 SELECT HARDWARE**

SINGLE HEIGHT WALL HUNG OVERHEADS

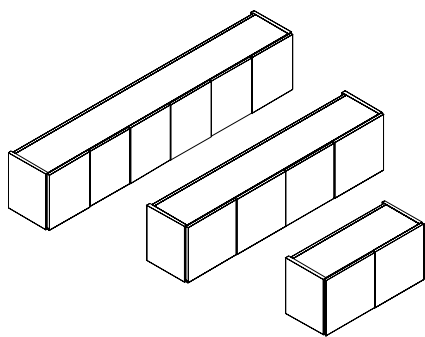

PANEL DOOR - 6/4/2 DOOR

STANDARD FEATURES

- Finished top
- Interior cabinet depth 12.5"
- Mounting wall rail included
- Tasklight concealment apron rail
- Touch latch
- Veneer interior

[CLICK HERE TO VIEW PRODUCT INDEX](#)

**1 SELECT A STYLE**

DIMENSIONS		STYLE NUMBER	LIST PRICE	STYLE NUMBER	LIST PRICE	STYLE NUMBER	LIST PRICE
W" x D" x H"	WGT	"W" Veneer Veneer Top Veneer Chassis		"G" HPL High Pressure Laminate Top Veneer Chassis		"M" TFL Thermally Fused Laminate Top Thermally Fused Laminate Chassis	
<b>6 Door</b>							
105 x 14 x 18	275	SPC10518WH330W	3609	"G" Option N/A		"M" Option N/A	
99 x 14 x 18	255	SPC9918WH330W	3464	"G" Option N/A		"M" Option N/A	
93 x 14 x 18	240	SPC9318WH330W	3398	"G" Option N/A		"M" Option N/A	
87 x 14 x 18	225	SPC8718WH330W	3262	"G" Option N/A		"M" Option N/A	
<b>4 Door</b>							
83 x 14 x 18	210	SPC8318WH330W	3198	"G" Option N/A		"M" Option N/A	
76 x 14 x 18	195	SPC7618WH330W	2906	"G" Option N/A		"M" Option N/A	
70 x 14 x 18	180	SPC7018WH330W	2712	"G" Option N/A		"M" Option N/A	
64 x 14 x 18	160	SPC6418WH330W	2642	"G" Option N/A		"M" Option N/A	
58 x 14 x 18	135	SPC5818WH330W	2510	"G" Option N/A		"M" Option N/A	
47 x 14 x 18	125	SPC4718WH330W	2061	"G" Option N/A		"M" Option N/A	
<b>2 Door</b>							
35 x 14 x 18	75	SPC3518WH330W	1440	"G" Option N/A		"M" Option N/A	
29 x 14 x 18	65	SPC2918WH330W	1417	"G" Option N/A		"M" Option N/A	

**2 SELECT A FINISH**      **3 SELECT AN EDGE**      **5 OPTIONS**

"W" Veneer	"G" HPL	"M" TFL	Finish
WAC	-	-	Amber Cherry
WRC	-	-	Caramel Cherry
WIC	-	-	Crimson Cherry
WEC	-	-	Ebony Cherry
WHC	-	-	Honey Cherry
WOC	-	-	KoKo Cherry
WSC	-	-	Scotch Cherry
WAM	-	-	Alabaster Maple
WCM	-	-	Clear Maple
WWM	-	-	Wheat Maple
WBO	-	-	Blush Oak
WMO	-	-	Mocha Oak
WTO	-	-	Toast Oak
WWO	-	-	Wheat Oak
WEW	-	-	Executive Walnut
WRW	GRW	-	Gray Luster Walnut
WGW	-	-	Gunstock Walnut
WJW	-	-	Judicial Walnut
WNW	-	-	Natural Walnut
WTW	-	-	Studio Teak Walnut
WWP	-	-	Designer White

Edge Profile  
Option Not Available

**4 SELECT HARDWARE**

Hardware  
Option Not Available

- DOOR**
- D2: Door Lock - \$95 per Door Set
  - D6: Delete Doors - n/c
  - D95C: Soft Close Door Hinges - \$15 per Door
- INTERIOR CABINET LIGHTING**
- LEDPK starter kit includes Infeed, 1 Puck Interior Light and the ability to daisy chain up to 6 total Puck Lights
- LEDPK: LED Puck Starter Kit - \$295
  - PK: 1 LED Interior Light - \$125
- TASK LIGHTING**
- LT-LED24: 24" LED Tasklight - \$90
  - LT-LED48: 48" LED Tasklight - \$165
  - LT-LED60: 60" LED Tasklight - \$180
  - LC22: 20" LT-LED Tasklight Linking Cable - \$20
  - WAR-D: Delete Tasklight Concealment Apron Rail - Deduct \$175
  - LED24: 24" Slim Line Aluminum LED Tasklight - \$315
  - LED48: 48" Slim Line Aluminum LED Tasklight - \$445
  - LED60: 60" Slim Line Aluminum LED Tasklight - \$555
  - DPC: Link multiple tasklights up to 30W of power wattage. Deletes 1 power drive - Deduct \$85 per tasklight

SINGLE HEIGHT WALL HUNG OVERHEADS

MINI-ALUMINUM FRAME FROSTED GLASS - 6/4/2 DOOR

STANDARD FEATURES

- Finished top
- Frosted glass resists finger prints
- Interior cabinet depth 12.5"
- Mounting wall rail included
- Tasklight concealment apron rail
- Touch latch

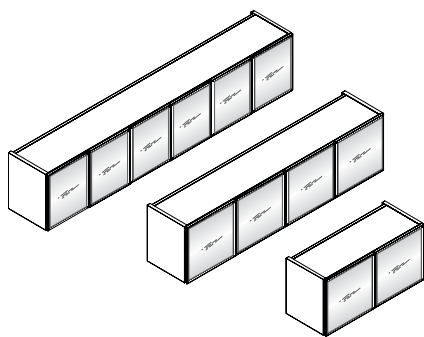

[CLICK HERE TO VIEW PRODUCT INDEX](#)

**1 SELECT A STYLE**

DIMENSIONS		STYLE NUMBER	LIST PRICE	STYLE NUMBER	LIST PRICE	STYLE NUMBER	LIST PRICE
W" x D" x H"	WGT	"W" Veneer Top Veneer Chassis		"G" HPL High Pressure Laminate Top Veneer Chassis		"M" TFL Thermally Fused Laminate Top Thermally Fused Laminate Chassis	
<b>6 Door</b>							
105 x 14 x 18	275	SPC10518WH331W	5740	"G" Option N/A		"M" Option N/A	
99 x 14 x 18	255	SPC9918WH331W	5321	"G" Option N/A		"M" Option N/A	
93 x 14 x 18	240	SPC9318WH331W	5264	"G" Option N/A		"M" Option N/A	
87 x 14 x 18	225	SPC8718WH331W	5206	"G" Option N/A		"M" Option N/A	
<b>4 Door</b>							
83 x 14 x 18	210	SPC8318WH331W	4614	"G" Option N/A		"M" Option N/A	
76 x 14 x 18	195	SPC7618WH331W	4054	"G" Option N/A		"M" Option N/A	
70 x 14 x 18	180	SPC7018WH331W	3941	"G" Option N/A		"M" Option N/A	
64 x 14 x 18	160	SPC6418WH331W	3884	"G" Option N/A		"M" Option N/A	
58 x 14 x 18	135	SPC5818WH331W	3826	"G" Option N/A		"M" Option N/A	
47 x 14 x 18	125	SPC4718WH331W	3208	"G" Option N/A		"M" Option N/A	
<b>2 Door</b>							
35 x 14 x 18	75	SPC3518WH331W	2090	"G" Option N/A		"M" Option N/A	
29 x 14 x 18	65	SPC2918WH331W	2061	"G" Option N/A		"M" Option N/A	

**2 SELECT A FINISH**      **3 SELECT AN EDGE**      **5 OPTIONS**

"W" Veneer	"G" HPL	"M" TFL	Finish
WAC	-	-	Amber Cherry
WRC	-	-	Caramel Cherry
WIC	-	-	Crimson Cherry
WEC	-	-	Ebony Cherry
WHC	-	-	Honey Cherry
WOC	-	-	KoKo Cherry
WSC	-	-	Scotch Cherry
WAM	-	-	Alabaster Maple
WCM	-	-	Clear Maple
WWM	-	-	Wheat Maple
WBO	-	-	Blush Oak
WMO	-	-	Mocha Oak
WTO	-	-	Toast Oak
WWO	-	-	Wheat Oak
WEW	-	-	Executive Walnut
WRW	GRW	-	Gray Luster Walnut
WGW	-	-	Gunstock Walnut
WJW	-	-	Judicial Walnut
WNW	-	-	Natural Walnut
WTW	-	-	Studio Teak Walnut
WWP	-	-	Designer White

Edge Profile  
Option Not Available

**4 SELECT HARDWARE**

Hardware  
Option Not Available

- DOOR**  
Mini-Frame:  
- D2-40WG: White Glass - \$195 per door  
- D2-G: Door Lock for Glass Doors - \$195 per Door Set  
- D9SC: Soft Close Door Hinges - \$15 per Door
- INTERIOR CABINET LIGHTING**  
LEDPK starter kit includes Infeed, 1 Puck Interior Light and the ability to daisy chain up to 6 total Puck Lights  
- LEDPK: LED Puck Starter Kit - \$295  
- PK: 1 LED Interior Light - \$125
- TASK LIGHTING**  
- LT-LED24: 24" LED Tasklight - \$90  
- LT-LED48: 48" LED Tasklight - \$165  
- LT-LED60: 60" LED Tasklight - \$180  
- LC22: 20" LT-LED Tasklight Linking Cable - \$20  
- WAR-D: Delete Tasklight Concealment Apron Rail - Deduct \$175  
- LED24: 24" Slim Line Aluminum LED Tasklight - \$315  
- LED48: 48" Slim Line Aluminum LED Tasklight - \$445  
- LED60: 60" Slim Line Aluminum LED Tasklight - \$555  
- DPC: Link multiple tasklights up to 30W of power wattage. Deletes 1 power drive - Deduct \$85 per tasklight

**WALL HUNG TACKBOARDS**

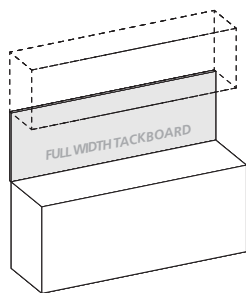

**FULL WIDTH TACKBOARDS**

**STANDARD FEATURES**

- Constructed of .5" thick fiberboard
- Fabric is precisely aligned and fitted to the tackboard
- Adhered to the rigid hardboard with staples

PRODUCT WIDTH	PANEL DIMENSION	SKU	COM	1	2	3	4	5	6	7	8	9	10	11/L1	12	13/L2
105	105 x .75 x 24	FTWH10524	510	630	689	748	807	866	925	984	1,043	1,102	1,161	1,220	1,279	1,397
99	99 x .75 x 24	FTWH9924	483	594	649	704	759	814	869	924	979	1,034	1,089	1,144	1,199	1,309
93	93 x .75 x 24	FTWH9324	447	558	609	660	711	762	813	864	915	966	1,017	1,068	1,119	1,221
87	87 x .75 x 24	FTWH8724	431	522	570	618	666	714	762	810	858	906	954	1,002	1,050	1,146
83	83 x .75 x 24	FTWH8324	406	498	544	590	636	682	728	774	820	866	912	958	1,004	1,096
76	76 x .75 x 24	FTWH7624	373	456	499	542	585	628	671	714	757	800	843	886	929	1,015
70	70 x .75 x 24	FTWH7024	341	420	460	500	540	580	620	660	700	740	780	820	860	940
64	64 x .75 x 24	FTWH6424	310	384	420	456	492	528	564	600	636	672	708	744	780	852
58	58 x .75 x 24	FTWH5824	283	348	380	412	444	476	508	540	572	604	636	668	700	764
47	47 x .75 x 24	FTWH4724	227	282	309	336	363	390	417	444	471	498	525	552	579	633
35	35 x .75 x 24	FTWH3524	169	210	230	250	270	290	310	330	350	370	390	410	430	470
29	29 x .75 x 24	FTWH2924	137	174	191	208	225	242	259	276	293	310	327	344	361	395

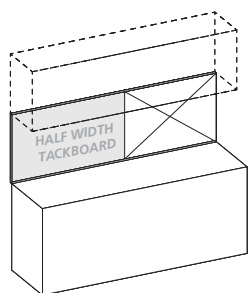

**WALL HUNG TACKBOARDS**

**HALF WIDTH TACKBOARDS**

**STANDARD FEATURES**

- Constructed of .5" thick fiberboard
- Fabric is precisely aligned and fitted to the tackboard
- Adhered to the rigid hardboard with staples

**Notes**

- Half width tackboards can be specified and combined with a Veneer Panel, Marker Board, Slat Wall or Glass Board. See "Half Width" items under product width.
- Must specify Right or left facing tackboard

PRODUCT WIDTH	PANEL DIMENSION	SKU	COM	1	2	3	4	5	6	7	8	9	10	11/L1	12	13/L2
105 Half Width	52.5 x .75 x 24	FTWH5224	255	315	345	374	404	433	463	492	522	551	581	610	640	699
99 Half Width	49.5 x .75 x 24	FTWH4924	242	297	325	352	380	407	435	462	490	517	545	575	600	655
93 Half Width	46.5 x .75 x 24	FTWH4624	224	279	305	330	356	381	407	432	458	483	509	534	560	611
87 Half Width	43.5 x .75 x 24	FTWH4324	216	261	285	309	333	357	381	405	429	453	477	501	525	573
83 Half Width	41.5 x .75 x 24	FTWH4124	203	249	272	295	318	341	364	387	410	433	456	479	502	548
76 Half Width	38 x .75 x 24	FTWH3824	187	228	250	271	293	314	336	357	379	400	422	443	465	508
70 Half Width	35 x .75 x 24	FTWH3524	171	210	230	250	270	290	310	330	350	370	390	410	430	470
64 Half Width	32 x .75 x 24	FTWH3224	155	192	210	228	246	264	282	300	318	336	354	372	390	426

**WALL HUNG DRY MARKER BOARD**

**FULL WIDTH DRY MARKER BOARD**

**STANDARD FEATURES**

- Dry marker panel has edge trim molding
- Standard magnetic surface

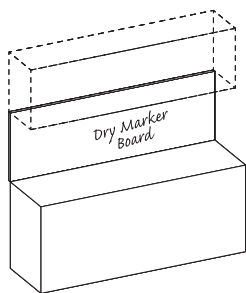

PRODUCT WIDTH	PANEL DIMENSION	SKU	LIST
105	105 x .75 x 24	DMWH10524	1260
99	99 x .75 x 24	DMWH9924	1188
93	93 x .75 x 24	DMWH9324	1116
87	87 x .75 x 24	DMWH8724	1044
83	83 x .75 x 24	DMWH8324	984
76	76 x .5 x 24	DMWH7624	912
70	70 x .75 x 24	DMWH7024	840
64	64 x .75 x 24	DMWH6424	768
58	58 x .75 x 24	DMWH5824	696
47	47 x .75 x 24	DMWH4724	564
35	35 x .75 x 24	DMWH3524	420
29	29 x .75 x 24	DMWH2924	348

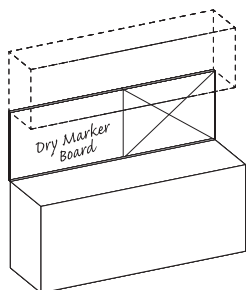

**WALL HUNG DRY MARKER BOARD**

**HALF WIDTH DRY MARKER BOARD**

**STANDARD FEATURES**

- Dry marker panel has edge trim molding
- Standard magnetic surface

**Notes**

- Half width dry marker boards can be specified and combined with a Tackboard, Veneer Panel, Slat Wall or Glass Board. See "Half Width" items under product width.
- Must specify Right or left facing dry marker board

PRODUCT WIDTH	PANEL DIMENSION	SKU	LIST
105 Half Width	52.5 x .75 x 24	DMWH5224	606
99 Half Width	49.5 x .75 x 24	DMWH4924	570
93 Half Width	46.5 x .75 x 24	DMWH4624	558
87 Half Width	43.5 x .75 x 24	DMWH4324	522
83 Half Width	41.5 x .75 x 24	DMWH4124	498
76 Half Width	38 x .75 x 24	DMWH3824	456
70 Half Width	35 x .75 x 24	DMWH3524	420
64 Half Width	32 x .75 x 24	DMWH3224	384

**WALL HUNG VENEER PANEL**

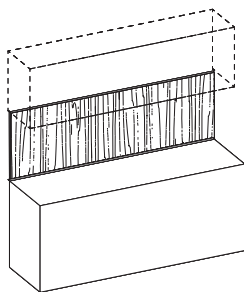

**FULL WIDTH VENEER PANEL**

**STANDARD FEATURES**

- Can be used with or without overhead cabinet.
- Required for other accessory panels.
- Veneer edges.
- Vertical wire channels on back for task light cords.
- Steel mounting wall channel is recessed for flush mounting.

PRODUCT WIDTH	PANEL DIMENSION	SKU	LIST
105	105 x .75 x 24	VPWH10524	1050
99	99 x .75 x 24	VPWH9924	990
93	93 x .75 x 24	VPWH9324	930
87	87 x .75 x 24	VPWH8724	870
83	83 x .75 x 24	VPWH8324	820
76	76 x .75 x 24	VPWH7624	760
70	70 x .75 x 24	VPWH7024	700
64	64 x .75 x 24	VPWH6424	640
58	58 x .75 x 24	VPWH5824	580
47	47 x .75 x 24	VPWH4724	470
35	35 x .75 x 24	VPWH3524	350
29	29 x .75 x 24	VPWH2924	290

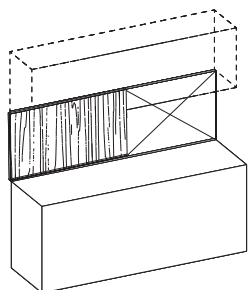

**WALL HUNG VENEER PANEL**

**HALF WIDTH VENEER PANEL**

**STANDARD FEATURES**

- Can be used with or without overhead cabinet.
- Required for other accessory panels.
- Veneer edges.
- Vertical wire channels on back for task light cords.
- Steel mounting wall channel is recessed for flush mounting.

**Notes**

- Half width veneer panels can be specified and combined with a Tackboard, Marker Board, Slat Wall or Glass Board. See "Half Width" items under product width.
- Must specify Right or left facing veneer panel

PRODUCT WIDTH	PANEL DIMENSION	SKU	LIST
105 Half Width	52.5 x .75 x 24	VPWH5224	525
99 Half Width	49.5 x .75 x 24	VPWH4924	495
93 Half Width	46.5 x .75 x 24	VPWH4624	465
87 Half Width	43.5 x .75 x 24	VPWH4324	435
83 Half Width	41.5 x .75 x 24	VPWH4124	415
76 Half Width	38 x .75 x 24	VPWH3824	380
70 Half Width	35 x .75 x 24	VPWH3524	350
64 Half Width	32 x .75 x 24	VPWH3224	320

WALL HUNG GLASSBOARD

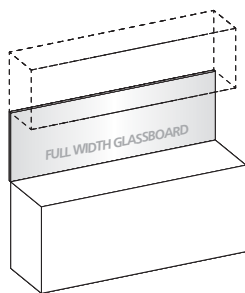

FULL WIDTH TACKBOARDS

STANDARD FEATURES

- 4 mm tempered glass
- Use glass cleaner or alcohol to clean
- Standard dry erase markers may be used
- Earth magnets are required to hold items securely in place
- Hung with Z-Strip mounting system

PRODUCT WIDTH	PANEL DIMENSION	SKU	LIST
105	105 x .75 x 24	GBWH10524	2815
99	99 x .75 x 24	GBWH9924	2807
93	93 x .75 x 24	GBWH9324	2647
87	87 x .75 x 24	GBWH8724	2487
83	83 x .75 x 24	GBWH8324	2380
76	76 x .75 x 24	GBWH7624	2193
70	70 x .75 x 24	GBWH7024	2033
64	64 x .75 x 24	GBWH6424	1873
58	58 x .75 x 24	GBWH5824	1712
47	47 x .75 x 24	GBWH4724	1419
35	35 x .75 x 24	GBWH3524	1098
29	29 x .75 x 24	GBWH2924	938

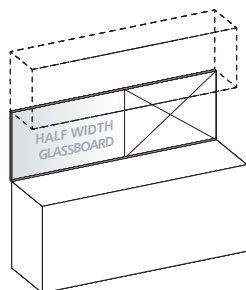

WALL HUNG GLASSBOARD

HALF WIDTH TACKBOARDS

STANDARD FEATURES

- 4 mm tempered glass
- Use glass cleaner or alcohol to clean
- Standard dry erase markers may be used
- Earth magnets are required to hold items securely in place
- Hung with Z-Strip mounting system

Notes

- Half width glassboards can be specified and combined with a Tackboard, Veneer panel, Marker Board or Slat Wall. See "Half Width" items under product width.
- Must specify Right or left facing glassboard

PRODUCT WIDTH	PANEL DIMENSION	SKU	LIST
105 Half Width	52.5 x .75 x 24	GBWH5224	1565
99 Half Width	49.5 x .75 x 24	GBWH4924	1485
93 Half Width	46.5 x .75 x 24	GBWH4624	1405
87 Half Width	43.5 x .75 x 24	GBWH4324	1325
83 Half Width	41.5 x .75 x 24	GBWH4124	1272
76 Half Width	38 x .75 x 24	GBWH3824	1185
70 Half Width	35 x .75 x 24	GBWH3524	1098
64 Half Width	32 x .75 x 24	GBWH3224	1018



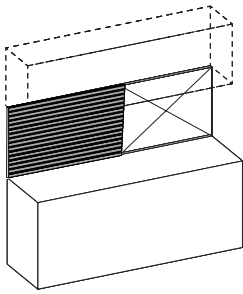

**HALF WIDTH SLAT WALL**

**STANDARD FEATURES**

- Available in silver or black
- For use on 42"/43" height consoles

**Notes**

- Half width slat walls can be specified and combined with a Tackboard, Veneer panel, Marker Board or Glassboard. See "Half Width" items under product width.
- Must specify Right or left facing slat wall

PRODUCT WIDTH	PANEL DIMENSION	SKU	LIST
105 Half Width	52.5 x .75 x 24	SWWH5224	525
99 Half Width	49.5 x .75 x 24	SWWH4924	495
93 Half Width	46.5 x .75 x 24	SWWH4624	465
87 Half Width	43.5 x .75 x 24	SWWH4324	435
83 Half Width	41.5 x .75 x 24	SWWH4124	415
76 Half Width	38 x .75 x 24	SWWH3824	380
70 Half Width	35 x .75 x 24	SWWH3524	350
64 Half Width	32 x .75 x 24	SWWH3224	320

SINGLE HEIGHT WALL HUNG OVERHEADS

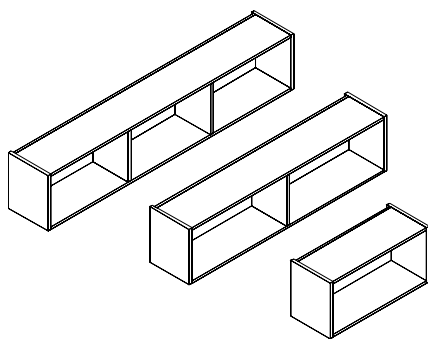

**OPEN STORAGE CABINET**

**STANDARD FEATURES**

- Finished top
- Interior cabinet depth 12.5"
- Mounting wall rail included
- Tasklight concealment apron rail

**NOTES**

- 3 Section: 1 or 2 optional sliding doors
- 2 Section: 1 optional sliding door
- 1 Section: No optional sliding door

[CLICK HERE TO VIEW PRODUCT INDEX](#)

**1 SELECT A STYLE**

DIMENSIONS		STYLE NUMBER	LIST PRICE	STYLE NUMBER	LIST PRICE	STYLE NUMBER	LIST PRICE
W" x D" x H"	WGT	"W" Veneer Top Veneer Chassis		"G" HPL High Pressure Laminate Top Veneer Chassis		"M" TFL Thermally Fused Laminate Top Thermally Fused Laminate Chassis	
<b>3 Section</b>							
105 x 14 x 18	260	SPC10518WH332W	3250	"G" Option N/A		"M" Option N/A	
99 x 14 x 18	240	SPC9918WH332W	3117	"G" Option N/A		"M" Option N/A	
93 x 14 x 18	225	SPC9318WH332W	3076	"G" Option N/A		"M" Option N/A	
87 x 14 x 18	210	SPC8718WH332W	2952	"G" Option N/A		"M" Option N/A	
83 x 14 x 18	200	SPC8318WH332W	2896	"G" Option N/A		"M" Option N/A	
76 x 14 x 18	185	SPC7618WH332W	2634	"G" Option N/A		"M" Option N/A	
<b>2 Section</b>							
70 x 14 x 18	170	SPC7018WH332W	2514	"G" Option N/A		"M" Option N/A	
64 x 14 x 18	140	SPC6418WH332W	2395	"G" Option N/A		"M" Option N/A	
58 x 14 x 18	125	SPC5818WH332W	2280	"G" Option N/A		"M" Option N/A	
47 x 14 x 18	115	SPC4718WH332W	1872	"G" Option N/A		"M" Option N/A	
<b>1 Section</b>							
35 x 14 x 18	60	SPC3518WH332W	1371	"G" Option N/A		"M" Option N/A	
29 x 14 x 18	50	SPC2918WH332W	1337	"G" Option N/A		"M" Option N/A	

**2 SELECT A FINISH**      **3 SELECT AN EDGE**      **5 OPTIONS**

"W" Veneer	"G" HPL	"M" TFL	Finish
WAC	-	-	Amber Cherry
WRC	-	-	Caramel Cherry
WIC	-	-	Crimson Cherry
WEC	-	-	Ebony Cherry
WHC	-	-	Honey Cherry
WOC	-	-	KoKo Cherry
WSC	-	-	Scotch Cherry
WAM	-	-	Alabaster Maple
WCM	-	-	Clear Maple
WWM	-	-	Wheat Maple
WBO	-	-	Blush Oak
WMO	-	-	Mocha Oak
WTO	-	-	Toast Oak
WWO	-	-	Wheat Oak
WEW	-	-	Executive Walnut
WRW	GRW	-	Gray Luster Walnut
GW	-	-	Gunstock Walnut
WJW	-	-	Judicial Walnut
WNW	-	-	Natural Walnut
WTW	-	-	Studio Teak Walnut
WWP	-	-	Designer White

Edge Profile  
Option Not Available

**4 SELECT HARDWARE**

Hardware  
Option Not Available

**DOOR**  
- Sliding Door:  
- SLD17WD: Wood - \$250 per door  
- SLD17FD: Mini-Frame Frosted Glass - \$350 per door

**INTERIOR CABINET LIGHTING**  
LEDPK starter kit includes Infeed, 1 Puck Interior Light and the ability to daisy chain up to 6 total Puck Lights  
- LEDPK: LED Puck Starter Kit - \$295  
- PK: 1 LED Interior Light - \$125

**TASK LIGHTING**  
- LT-LED24: 24" LED Tasklight - \$90  
- LT-LED48: 48" LED Tasklight - \$165  
- LT-LED60: 60" LED Tasklight - \$180  
- LC22: 20" LT-LED Tasklight Linking Cable - \$20  
- WAR-D: Delete Tasklight Concealment Apron Rail - Deduct \$175  
- LED24: 24" Slim Line Aluminum LED Tasklight - \$315  
- LED48: 48" Slim Line Aluminum LED Tasklight - \$445  
- LED60: 60" Slim Line Aluminum LED Tasklight - \$555  
- DPC: Link multiple tasklights up to 30W of power wattage. Deletes 1 power drive - Deduct \$85 per tasklight

DOUBLE HEIGHT WALL HUNG OVERHEADS

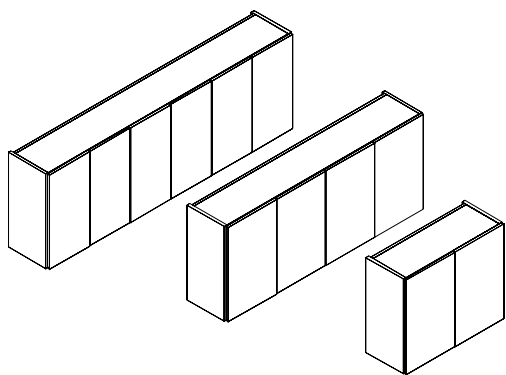

PANEL DOOR - 6/4/2 DOOR

STANDARD FEATURES

- Adjustable finished shelf behind each door section
- Black painted top
- Interior shelf depth 12"
- Mounting wall rail included
- Tasklight concealment apron rail
- Touch latch

[CLICK HERE TO VIEW PRODUCT INDEX](#)

**1 SELECT A STYLE**

DIMENSIONS		STYLE NUMBER	LIST PRICE	STYLE NUMBER	LIST PRICE	STYLE NUMBER	LIST PRICE
W" x D" x H"	WGT	"W" Veneer Top Veneer Chassis		"G" HPL High Pressure Laminate Top Veneer Chassis		"M" TFL Thermally Fused Laminate Top Thermally Fused Laminate Chassis	
<b>6 Door</b>							
93 x 14 x 29	265	SPC9329WH330W	3903	"G" Option N/A		"M" Option N/A	
87 x 14 x 29	250	SPC8729WH330W	3842	"G" Option N/A		"M" Option N/A	
<b>4 Door</b>							
70 x 14 x 29	220	SPC7029WH330W	3292	"G" Option N/A		"M" Option N/A	
64 x 14 x 29	200	SPC6429WH330W	3229	"G" Option N/A		"M" Option N/A	
58 x 14 x 29	180	SPC5829WH330W	3108	"G" Option N/A		"M" Option N/A	
<b>2 Door</b>							
35 x 14 x 29	105	SPC3529WH330W	1745	"G" Option N/A		"M" Option N/A	
29 x 14 x 29	95	SPC2929WH330W	1685	"G" Option N/A		"M" Option N/A	

**2 SELECT A FINISH**

"W" Veneer	"G" HPL	"M" TFL	Finish
WAC	-	-	Amber Cherry
WRC	-	-	Caramel Cherry
WIC	-	-	Crimson Cherry
WEC	-	-	Ebony Cherry
WHC	-	-	Honey Cherry
WOC	-	-	KoKo Cherry
WSC	-	-	Scotch Cherry
WAM	-	-	Alabaster Maple
WCM	-	-	Clear Maple
WWM	-	-	Wheat Maple
WBO	-	-	Blush Oak
WMO	-	-	Mocha Oak
WTO	-	-	Toast Oak
WWO	-	-	Wheat Oak
WEW	-	-	Executive Walnut
WRW	GRW	-	Gray Luster Walnut
WGW	-	-	Gunstock Walnut
WJW	-	-	Judicial Walnut
WNW	-	-	Natural Walnut
WTW	-	-	Studio Teak Walnut
WWP	-	-	Designer White

**3 SELECT AN EDGE**

Edge Profile  
Option Not Available

**4 SELECT HARDWARE**

Hardware  
Option Not Available

**5 OPTIONS**

- DOOR**
- D2: Door Lock - \$95 per Door Set
  - D9SC: Soft Close Door Hinges - \$15 per Door
- SHELVES**
- S714F: Replace Standard Shelf with Heavy Duty Lumber 1" Shelf - \$75 per Shelf ("M" Styles - n/a)
- TASK LIGHTING**
- LT-LED24: 24" LED Tasklight - \$90
  - LT-LED48: 48" LED Tasklight - \$165
  - LT-LED60: 60" LED Tasklight - \$180
  - LC22: 20" LT-LED Tasklight Linking Cable - \$20
  - WAR-D: Delete Tasklight Concealment Apron Rail - Deduct \$175
  - LED24: 24" Slim Line Aluminum LED Tasklight - \$315
  - LED48: 48" Slim Line Aluminum LED Tasklight - \$445
  - LED60: 60" Slim Line Aluminum LED Tasklight - \$555
  - DPC: Link multiple tasklights up to 30W of power wattage. Deletes 1 power drive - Deduct \$85 per tasklight

DOUBLE HEIGHT WALL HUNG OVERHEADS

MINI-ALUMINUM FRAME FROSTED GLASS - 6/4/2 DOOR

STANDARD FEATURES

- 1 wood shelf per section
- Black painted top
- Interior shelf depth 12"
- Mounting wall rail included
- Tasklight concealment apron rail
- Touch latch

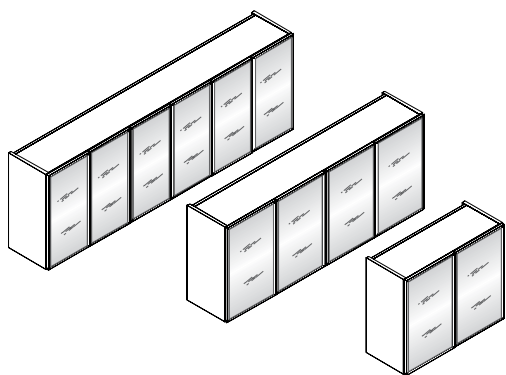

[CLICK HERE TO VIEW PRODUCT INDEX](#)

**1 SELECT A STYLE**

DIMENSIONS		STYLE NUMBER	LIST PRICE	STYLE NUMBER	LIST PRICE	STYLE NUMBER	LIST PRICE
W" x D" x H"	WGT	"W" Veneer Top Veneer Chassis		"G" HPL High Pressure Laminate Top Veneer Chassis		"M" TFL Thermally Fused Laminate Top Thermally Fused Laminate Chassis	
<b>6 Door</b>							
93 x 14 x 29	265	SPC9329WH331W	6314	"G" Option N/A		"M" Option N/A	
87 x 14 x 29	250	SPC8729WH331W	6165	"G" Option N/A		"M" Option N/A	
<b>4 Door</b>							
70 x 14 x 29	220	SPC7029WH331W	4822	"G" Option N/A		"M" Option N/A	
64 x 14 x 29	200	SPC6429WH331W	4726	"G" Option N/A		"M" Option N/A	
58 x 14 x 29	180	SPC5829WH331W	4575	"G" Option N/A		"M" Option N/A	
<b>2 Door</b>							
35 x 14 x 29	105	SPC3529WH331W	2521	"G" Option N/A		"M" Option N/A	
29 x 14 x 29	95	SPC2929WH331W	2400	"G" Option N/A		"M" Option N/A	

**2 SELECT A FINISH**      **3 SELECT AN EDGE**      **5 OPTIONS**

"W" Veneer	"G" HPL	"M" TFL	Finish
WAC	-	-	Amber Cherry
WRC	-	-	Caramel Cherry
WIC	-	-	Crimson Cherry
WEC	-	-	Ebony Cherry
WHC	-	-	Honey Cherry
WOC	-	-	KoKo Cherry
WSC	-	-	Scotch Cherry
WAM	-	-	Alabaster Maple
WCM	-	-	Clear Maple
WWM	-	-	Wheat Maple
WBO	-	-	Blush Oak
WMO	-	-	Mocha Oak
WTO	-	-	Toast Oak
WWO	-	-	Wheat Oak
WEW	-	-	Executive Walnut
WRW	GRW	-	Gray Luster Walnut
GW	-	-	Gunstock Walnut
WJW	-	-	Judicial Walnut
WNW	-	-	Natural Walnut
WTW	-	-	Studio Teak Walnut
WWP	-	-	Designer White

Edge Profile  
Option Not Available

**4 SELECT HARDWARE**

Hardware  
Option Not Available

- DOOR**  
Mini-Frame:  
 - D2-40WG: White Glass - \$295 per door  
 - D2-G: Door Lock for Glass Doors - \$195 per Door Set  
 - D6: Delete Doors - n/c  
 - D9SC: Soft Close Door Hinges - \$15 per Door
- INTERIOR CABINET LIGHTING**  
 LEDPK starter kit includes Infeed, 1 Puck Interior Light and the ability to daisy chain up to 6 total Puck Lights  
 - LEDPK: LED Puck Starter Kit - \$295  
 - PK: 1 LED Interior Light - \$125
- TASK LIGHTING**  
 - LT-LED24: 24" LED Tasklight - \$90  
 - LT-LED48: 48" LED Tasklight - \$165  
 - LT-LED60: 60" LED Tasklight - \$180  
 - LC22: 20" LT-LED Tasklight Linking Cable - \$20  
 - WAR-D: Delete Tasklight Concealment Apron Rail - Deduct \$175  
 - LED24: 24" Slim Line Aluminum LED Tasklight - \$315  
 - LED48: 48" Slim Line Aluminum LED Tasklight - \$445  
 - LED60: 60" Slim Line Aluminum LED Tasklight - \$555  
 - DPC: Link multiple tasklights up to 30W of power wattage. Deletes 1 power drive - Deduct \$85 per tasklight
- SHELF**  
 - GS14F: Replace Standard Shelves with Glass Shelves - \$85 per Shelf

DOUBLE HEIGHT WALL HUNG OVERHEADS

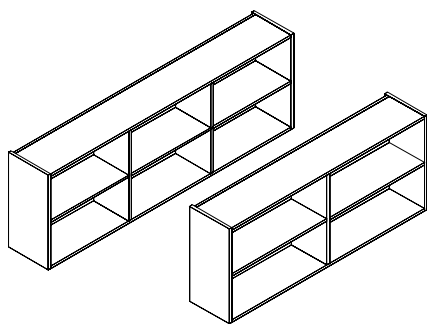

OPEN STORAGE CABINET

STANDARD FEATURES

- 1 wood shelf per section
- Black painted top
- Interior cabinet depth 12.5"
- Interior shelf depth 12"
- Mounting wall rail included
- Tasklight concealment apron rail

- 1 Section: No optional sliding door

NOTES

- 3 Section: 1 or 2 optional sliding doors
- 2 Section: 1 optional sliding door

[CLICK HERE TO VIEW PRODUCT INDEX](#)

1 SELECT A STYLE

DIMENSIONS		STYLE NUMBER	LIST PRICE	STYLE NUMBER	LIST PRICE	STYLE NUMBER	LIST PRICE
W" x D" x H"	WGT	"W" Veneer Top Veneer Chassis		"G" High Pressure Laminate Top HPL Veneer Chassis		"M" Thermally Fused Laminate Top TFL Thermally Fused Laminate Chassis	
<b>3 Section</b>							
93 x 14 x 29	205	SPC9329WH332W	3574	"G" Option N/A		"M" Option N/A	
87 x 14 x 29	190	SPC8729WH332W	3504	"G" Option N/A		"M" Option N/A	
<b>2 Section</b>							
70 x 14 x 29	190	SPC7029WH332W	3033	"G" Option N/A		"M" Option N/A	
64 x 14 x 29	170	SPC6429WH332W	2924	"G" Option N/A		"M" Option N/A	
58 x 14 x 29	150	SPC5829WH332W	2814	"G" Option N/A		"M" Option N/A	
<b>1 Section</b>							
35 x 14 x 29	70	SPC3529WH332W	1590	"G" Option N/A		"M" Option N/A	
29 x 14 x 29	60	SPC2929WH332W	1549	"G" Option N/A		"M" Option N/A	

2 SELECT A FINISH

"W" Veneer	"G" HPL	"M" TFL	Finish
WAC	-	-	Amber Cherry
WRC	-	-	Caramel Cherry
WIC	-	-	Crimson Cherry
WEC	-	-	Ebony Cherry
WHC	-	-	Honey Cherry
WOC	-	-	KoKo Cherry
WSC	-	-	Scotch Cherry
WAM	-	-	Alabaster Maple
WCM	-	-	Clear Maple
WWM	-	-	Wheat Maple
WBO	-	-	Blush Oak
WMO	-	-	Mocha Oak
WTO	-	-	Toast Oak
WWO	-	-	Wheat Oak
WEW	-	-	Executive Walnut
WRW	GRW	-	Gray Luster Walnut
GW	-	-	Gunstock Walnut
WJW	-	-	Judicial Walnut
WNW	-	-	Natural Walnut
WTW	-	-	Studio Teak Walnut
WWP	-	-	Designer White

3 SELECT AN EDGE

Edge Profile  
Option Not Available

4 SELECT HARDWARE

Hardware  
Option Not Available

5 OPTIONS

DOOR

- Sliding Door:
  - SLD29WD: Wood - \$295 per door
  - SLD29FD: Mini-Frame Frosted Glass - \$395 per door

INTERIOR CABINET LIGHTING

- LEDPK starter kit includes Infeed, 1 Puck Interior Light and the ability to daisy chain up to 6 total Puck Lights
  - LEDPK: LED Puck Starter Kit - \$295
  - PK: 1 LED Interior Light - \$125

TASK LIGHTING

- LT-LED24: 24" LED Tasklight - \$90
- LT-LED48: 48" LED Tasklight - \$165
- LT-LED60: 60" LED Tasklight - \$180
- LC22: 20" LT-LED Tasklight Linking Cable - \$20
- WAR-D: Delete Tasklight Concealment Apron Rail - Deduct \$175
- LED24: 24" Slim Line Aluminum LED Tasklight - \$315
- LED48: 48" Slim Line Aluminum LED Tasklight - \$445
- LED60: 60" Slim Line Aluminum LED Tasklight - \$555
- DPC: Link multiple tasklights up to 30W of power wattage. Deletes 1 power drive - Deduct \$85 per tasklight

SHELVES

- GS14F: Replace Standard Shelves with Glass Shelves - \$85 per Shelf
- S714F: Replace Standard Shelf with Heavy Duty Lumber 1" Shelf - \$75 per Shelf ("M" Styles - n/a)

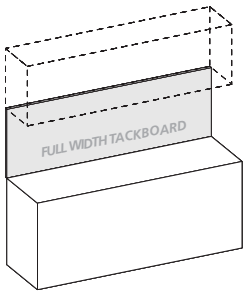

[CLICK HERE TO VIEW PRODUCT INDEX](#)

**1 SELECT A STYLE**

DIMENSIONS		STYLE NUMBER	LIST PRICE	STYLE NUMBER	LIST PRICE	STYLE NUMBER	LIST PRICE
W" x D" x H"	WGT						

**2 SELECT A FINISH**

**3 SELECT AN EDGE**

**5 OPTIONS**

**4 SELECT HARDWARE**

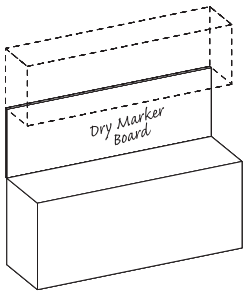

[CLICK HERE TO VIEW PRODUCT INDEX](#)

**1 SELECT A STYLE**

DIMENSIONS		STYLE NUMBER	LIST PRICE	STYLE NUMBER	LIST PRICE	STYLE NUMBER	LIST PRICE
W" x D" x H"	WGT						

**2 SELECT A FINISH**

**3 SELECT AN EDGE**

**5 OPTIONS**

**4 SELECT HARDWARE**

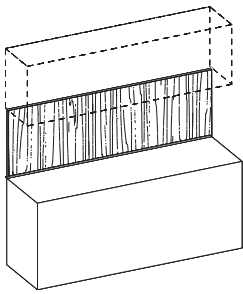

[CLICK HERE TO VIEW PRODUCT INDEX](#)

**1 SELECT A STYLE**

DIMENSIONS		STYLE NUMBER	LIST PRICE	STYLE NUMBER	LIST PRICE	STYLE NUMBER	LIST PRICE
W" x D" x H"	WGT						

**2 SELECT A FINISH**

**3 SELECT AN EDGE**

**5 OPTIONS**

**4 SELECT HARDWARE**



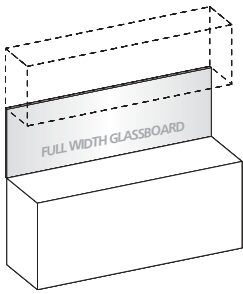

[CLICK HERE TO VIEW PRODUCT INDEX](#)

**1 SELECT A STYLE**

DIMENSIONS		STYLE NUMBER	LIST PRICE	STYLE NUMBER	LIST PRICE	STYLE NUMBER	LIST PRICE
W" x D" x H"	WGT						

**2 SELECT A FINISH**

**3 SELECT AN EDGE**

**5 OPTIONS**

**4 SELECT HARDWARE**

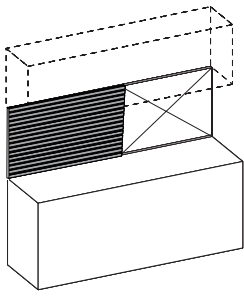

[CLICK HERE TO VIEW PRODUCT INDEX](#)

**1 SELECT A STYLE**

DIMENSIONS		STYLE NUMBER	LIST PRICE	STYLE NUMBER	LIST PRICE	STYLE NUMBER	LIST PRICE
W" x D" x H"	WGT						

**2 SELECT A FINISH**

**3 SELECT AN EDGE**

**5 OPTIONS**

**4 SELECT HARDWARE**

OVERHEAD TOWER EXTENSION

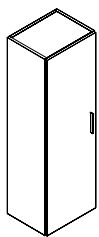

Left Hinge

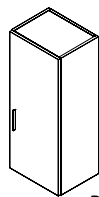

Right Hinge

PANEL DOORS- FULL STORAGE

STANDARD FEATURES

- 42" Height - 2 adjustable wood shelves
- 54" Height - 3 adjustable wood shelves
- Interior shelf depth 12"
- "W" styles - 42" H units finished top, 54" H units black painted top

for Open Plan use. Select OPB Option for Open Plan application

NOTES

- Soft close door option not available on 54" units
- Unit has black back panel and is not designed

[CLICK HERE TO VIEW PRODUCT INDEX](#)

**1 SELECT A STYLE**

DIMENSIONS		STYLE NUMBER	LIST PRICE	STYLE NUMBER	LIST PRICE	STYLE NUMBER	LIST PRICE
W" x D" x H"	WGT	"W" Veneer Veneer Top Veneer Chassis		"G" HPL High Pressure Laminate Top Veneer Chassis		"M" TFL Thermally Fused Laminate Top Thermally Fused Laminate Chassis	
<b>Left Hinge</b>							
17.5 x 14 x 54	95	SPC1754OH340W	2088	"G" Option N/A		"M" Option N/A	
14.5 x 14 x 54	90	SPC1454OH340W	2020	"G" Option N/A		"M" Option N/A	
17.5 x 14 x 42	70	SPC1742OH340W	1611	"G" Option N/A		"M" Option N/A	
14.5 x 14 x 42	65	SPC1442OH340W	1553	"G" Option N/A		"M" Option N/A	
<b>Right Hinge</b>							
17.5 x 14 x 54	95	SPC1754OH341W	2088	"G" Option N/A		"M" Option N/A	
14.5 x 14 x 54	90	SPC1454OH341W	2020	"G" Option N/A		"M" Option N/A	
17.5 x 14 x 42	70	SPC1742OH341W	1611	"G" Option N/A		"M" Option N/A	
14.5 x 14 x 42	65	SPC1442OH341W	1553	"G" Option N/A		"M" Option N/A	

**2 SELECT A FINISH**

"W" Veneer	"G" HPL	"M" TFL	Finish
WAC	-	-	Amber Cherry
WRC	-	-	Caramel Cherry
WIC	-	-	Crimson Cherry
WEC	-	-	Ebony Cherry
WHC	-	-	Honey Cherry
WOC	-	-	KoKo Cherry
WSC	-	-	Scotch Cherry
WAM	-	-	Alabaster Maple
WCM	-	-	Clear Maple
WWM	-	-	Wheat Maple
WBO	-	-	Blush Oak
WMO	-	-	Mocha Oak
WTO	-	-	Toast Oak
WWO	-	-	Wheat Oak
WEW	-	-	Executive Walnut
WRW	GRW	-	Gray Luster Walnut
GW	-	-	Gunstock Walnut
WJW	-	-	Judicial Walnut
WNW	-	-	Natural Walnut
WTW	-	-	Studio Teak Walnut
WWP	-	-	Designer White

**3 SELECT AN EDGE**

Edge Profile  
Option Not Available

**5 OPTIONS**

- DOOR**
- D2: Door Lock - \$95 per Door
  - D6: Delete Doors - n/c
  - D9SC: Soft Close Door Hinges - \$15 per Door
- OPEN PLAN**
- OPB: "W" "G" Style - Modify Unit for Open Plan Application - \$295
- SHELVES**
- S714F: Replace Standard Shelf with Heavy Duty Lumber 1" Shelf - \$75 per Shelf ("M" Styles - n/a)

**4 SELECT HARDWARE**

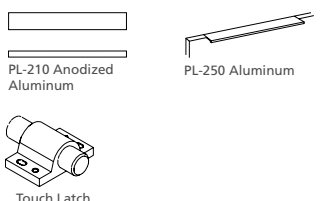

**SIT-ON TOWER EXTENSION**

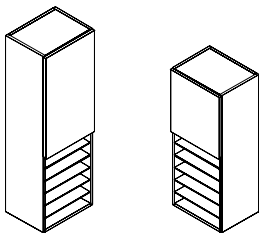

**PANEL DOORS - HALF STORAGE / PAPER SLOTS**

**STANDARD FEATURES**

- 42" Height - no shelf
- 54" Height - 1 wood shelf behind door
- Finger pull or touch latch
- Interior cabinet depth 12.5"
- Interior shelf depth 12"
- Wood slots 42" (5) 54" (6)
- "W" styles - 42" H units finished top, 54" H units black painted top

- Doors open like overhead console
- Unit has black back panel and is not designed for Open Plan use. Select OPB Option for Open Plan application

NOTES

[CLICK HERE TO VIEW PRODUCT INDEX](#)

**1 SELECT A STYLE**

DIMENSIONS		STYLE NUMBER	LIST PRICE	STYLE NUMBER	LIST PRICE	STYLE NUMBER	LIST PRICE
W" x D" x H"	WGT	"W" Veneer Veneer Top Veneer Chassis		"G" HPL High Pressure Laminate Top Veneer Chassis		"M" TFL Thermally Fused Laminate Top Thermally Fused Laminate Chassis	
<b>Left Hinge</b>							
17.5 x 14 x 54	95	SPC1754OH408W	2107	"G" Option N/A		"M" Option N/A	
17.5 x 14 x 42	70	SPC1742OH408W	1635	"G" Option N/A		"M" Option N/A	
<b>Right Hinge</b>							
17.5 x 14 x 54	95	SPC1754OH409W	2107	"G" Option N/A		"M" Option N/A	
17.5 x 14 x 42	70	SPC1742OH409W	1635	"G" Option N/A		"M" Option N/A	

**2 SELECT A FINISH**

"W" Veneer	"G" HPL	"M" TFL	Finish
WAC	-	-	Amber Cherry
WRC	-	-	Caramel Cherry
WIC	-	-	Crimson Cherry
WEC	-	-	Ebony Cherry
WHC	-	-	Honey Cherry
WOC	-	-	KoKo Cherry
WSC	-	-	Scotch Cherry
WAM	-	-	Alabaster Maple
WCM	-	-	Clear Maple
WWM	-	-	Wheat Maple
WBO	-	-	Blush Oak
WMO	-	-	Mocha Oak
WTO	-	-	Toast Oak
WWO	-	-	Wheat Oak
WEW	-	-	Executive Walnut
WRW	GRW	-	Gray Luster Walnut
WGW	-	-	Gunstock Walnut
WJW	-	-	Judicial Walnut
WNW	-	-	Natural Walnut
WTW	-	-	Studio Teak Walnut
WWP	-	-	Designer White

**3 SELECT AN EDGE**

Edge Profile  
Option Not Available

**4 SELECT HARDWARE**

Hardware  
Option Not Available

**5 OPTIONS**

**DOOR**

- D2: Door Lock - \$95 per Door
- D6: Delete Doors - n/c
- D9SC: Soft Close Door Hinges - \$15 per Door

**OPEN PLAN**

- OPB: "W" "G" Style - Modify Unit for Open Plan Application - \$295

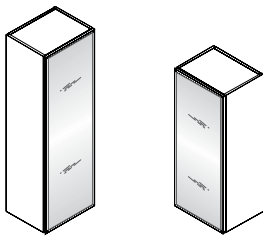

**SIT-ON TOWER EXTENSION**

**MINI-ALUMINUM FRAME FROSTED GLASS - FULL STORAGE**

**STANDARD FEATURES**

- 42" Height - 2 adjustable wood shelves
- 54" Height - 3 adjustable wood shelves
- Frosted glass resists finger prints
- Interior shelf depth 12"
- Touch latch
- "W" styles - 42" H units finished top, 54" H units black painted top

**units**

- Unit has black back panel and is not designed for Open Plan use. Select OPB Option for Open Plan application

**NOTES**

- Soft close door option not available on 54"

[CLICK HERE TO VIEW PRODUCT INDEX](#)

**1 SELECT A STYLE**

DIMENSIONS		STYLE NUMBER	LIST PRICE	STYLE NUMBER	LIST PRICE	STYLE NUMBER	LIST PRICE
W" x D" x H"	WGT	"W" Veneer Veneer Top Veneer Chassis		"G" HPL High Pressure Laminate Top Veneer Chassis		"M" TFL Thermally Fused Laminate Top Thermally Fused Laminate Chassis	
<b>Left Hinge</b>							
17.5 x 14 x 54	95	SPC1754OH363W	2429	"G" Option N/A		"M" Option N/A	
14.5 x 14 x 54	90	SPC1454OH363W	2371	"G" Option N/A		"M" Option N/A	
17.5 x 14 x 42	70	SPC1742OH363W	1967	"G" Option N/A		"M" Option N/A	
14.5 x 14 x 42	65	SPC1442OH363W	1898	"G" Option N/A		"M" Option N/A	
<b>Right Hinge</b>							
17.5 x 14 x 54	95	SPC1754OH364W	2429	"G" Option N/A		"M" Option N/A	
14.5 x 14 x 54	90	SPC1454OH364W	2371	"G" Option N/A		"M" Option N/A	
17.5 x 14 x 42	70	SPC1742OH364W	1967	"G" Option N/A		"M" Option N/A	
14.5 x 14 x 42	65	SPC1442OH364W	1898	"G" Option N/A		"M" Option N/A	

**2 SELECT A FINISH**

"W" Veneer	"G" HPL	"M" TFL	Finish
WAC	-	-	Amber Cherry
WRC	-	-	Caramel Cherry
WIC	-	-	Crimson Cherry
WEC	-	-	Ebony Cherry
WHC	-	-	Honey Cherry
WOC	-	-	KoKo Cherry
WSC	-	-	Scotch Cherry
WAM	-	-	Alabaster Maple
WCM	-	-	Clear Maple
WWM	-	-	Wheat Maple
WBO	-	-	Blush Oak
WMO	-	-	Mocha Oak
WTO	-	-	Toast Oak
WWO	-	-	Wheat Oak
WEW	-	-	Executive Walnut
WRW	GRW	-	Gray Luster Walnut
WGW	-	-	Gunstock Walnut
WJW	-	-	Judicial Walnut
WNW	-	-	Natural Walnut
WTW	-	-	Studio Teak Walnut
WWP	-	-	Designer White

**3 SELECT AN EDGE**

Edge Profile  
Option Not Available

**4 SELECT HARDWARE**

Hardware  
Option Not Available

**5 OPTIONS**

**DOOR**

Mini-Frame:

- D1-40WG: White Glass - \$395 ea.
- D2-G: Door Lock for Glass Doors - \$195 per Door Set
- D9SC: Soft Close Door Hinges - \$15 per Door

**INTERIOR CABINET LIGHTING**

LEDPK starter kit includes Infeed, 1 Puck Interior Light and the ability to daisy chain up to 6 total Puck Lights

- LEDPK: LED Puck Starter Kit - \$295

**OPEN PLAN**

- OPB: "W" "G" Style - Modify Unit for Open Plan Application - \$295

**SHELVES**

- GS14F: Replace Standard Shelves with Glass Shelves - \$85 per Shelf
- S714F: Replace Standard Shelf with Heavy Duty Lumber 1" Shelf - \$75 per Shelf ("M" Styles - n/a)

**SIT-ON TOWER EXTENSION**

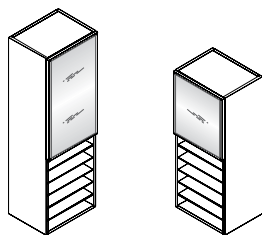

**MINI-ALUMINUM FRAME FROSTED GLASS - HALF STORAGE / PAPER SLOTS**

**STANDARD FEATURES**

- 42" Height - no shelf
- 54" Height - 1 wood shelf behind door
- Frosted glass resists finger prints
- Interior cabinet depth 12.5"
- Interior shelf depth 12"
- "W" styles - 42" H units finished top, 54" H units black painted top

for Open Plan use. Select OPB Option for Open Plan application

**NOTES**

-Unit has black back panel and is not designed

[CLICK HERE TO VIEW PRODUCT INDEX](#)

**1 SELECT A STYLE**

DIMENSIONS		STYLE NUMBER	LIST PRICE	STYLE NUMBER	LIST PRICE	STYLE NUMBER	LIST PRICE
W" x D" x H"	WGT	"W" Veneer Top Veneer Chassis		"G" High Pressure Laminate Top Veneer Chassis		"M" Thermally Fused Laminate Top Thermally Fused Laminate Chassis	
<b>Left Hinge</b>							
17.5 x 14 x 54	95	SPC1754OH416W	2486	"G" Option N/A		"M" Option N/A	
17.5 x 14 x 42	70	SPC1742OH416W	1963	"G" Option N/A		"M" Option N/A	
<b>Right Hinge</b>							
17.5 x 14 x 54	95	SPC1754OH417W	2486	"G" Option N/A		"M" Option N/A	
17.5 x 14 x 42	70	SPC1742OH417W	1963	"G" Option N/A		"M" Option N/A	

**2 SELECT A FINISH**

"W" Veneer	"G" HPL	"M" TFL	Finish
WAC	-	-	Amber Cherry
WRC	-	-	Caramel Cherry
WIC	-	-	Crimson Cherry
WEC	-	-	Ebony Cherry
WHC	-	-	Honey Cherry
WOC	-	-	KoKo Cherry
WSC	-	-	Scotch Cherry
WAM	-	-	Alabaster Maple
WCM	-	-	Clear Maple
WWM	-	-	Wheat Maple
WBO	-	-	Blush Oak
WMO	-	-	Mocha Oak
WTO	-	-	Toast Oak
WWO	-	-	Wheat Oak
WEW	-	-	Executive Walnut
WRW	GRW	-	Gray Luster Walnut
WGW	-	-	Gunstock Walnut
WJW	-	-	Judicial Walnut
WNW	-	-	Natural Walnut
WTW	-	-	Studio Teak Walnut
WWP	-	-	Designer White

**3 SELECT AN EDGE**

Edge Profile  
Option Not Available

**4 SELECT HARDWARE**

Hardware  
Option Not Available

**5 OPTIONS**

- DOOR**  
Mini-Frame:  
- D2-40WG: White Glass - \$295 ea.  
- D2-G: Door Lock for Glass Doors - \$195 per Door Set  
- D9SC: Soft Close Door Hinges - \$15 per Door
- INTERIOR CABINET LIGHTING**  
LEDPK starter kit includes Infeed, 1 Puck Interior Light and the ability to daisy chain up to 6 total Puck Lights  
- LEDPK: LED Puck Starter Kit - \$295
- OPEN PLAN**  
- OPB: "W" "G" Style - Modify Unit for Open Plan Application - \$295
- SHELVES**  
- GS14F: Replace Standard Shelves with Glass Shelves - \$85 per Shelf Available on 54"

OVERHEAD BOOKCASE CONSOLE

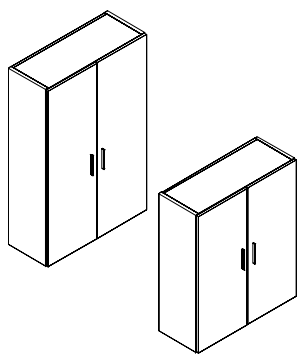

VERTICAL PANEL DOOR

STANDARD FEATURES

- 42" Height - 2 adjustable wood shelves
- 54" Height - 3 adjustable wood shelves
- Interior shelf depth 12"
- "W" styles - 42" H units finished top, 54" H units black painted top

for Open Plan use. Select OPB Option for Open Plan application

NOTES

- Soft close door option not available on 54" units
- Unit has black back panel and is not designed

[CLICK HERE TO VIEW PRODUCT INDEX](#)

**1 SELECT A STYLE**

DIMENSIONS		STYLE NUMBER	LIST PRICE	STYLE NUMBER	LIST PRICE	STYLE NUMBER	LIST PRICE
W" x D" x H"	WGT	"W" Veneer Veneer Top Veneer Chassis		"G" HPL High Pressure Laminate Top Veneer Chassis		"M" TFL Thermally Fused Laminate Top Thermally Fused Laminate Chassis	
<b>54" Height</b>							
35 x 14 x 54	130	SPC3554OH383W	2696	"G" Option N/A		"M" Option N/A	
29 x 14 x 54	120	SPC2954OH383W	2579	"G" Option N/A		"M" Option N/A	
<b>42" Height</b>							
35 x 14 x 42	120	SPC3542OH383W	2048	"G" Option N/A		"M" Option N/A	
29 x 14 x 42	110	SPC2942OH383W	1932	"G" Option N/A		"M" Option N/A	

**2 SELECT A FINISH**

"W" Veneer	"G" HPL	"M" TFL	Finish
WAC	-	-	Amber Cherry
WRC	-	-	Caramel Cherry
WIC	-	-	Crimson Cherry
WEC	-	-	Ebony Cherry
WHC	-	-	Honey Cherry
WOC	-	-	KoKo Cherry
WSC	-	-	Scotch Cherry
WAM	-	-	Alabaster Maple
WCM	-	-	Clear Maple
WWM	-	-	Wheat Maple
WBO	-	-	Blush Oak
WMO	-	-	Mocha Oak
WTO	-	-	Toast Oak
WWO	-	-	Wheat Oak
WEW	-	-	Executive Walnut
WRW	GRW	-	Gray Luster Walnut
WGW	-	-	Gunstock Walnut
WJW	-	-	Judicial Walnut
WNW	-	-	Natural Walnut
WTW	-	-	Studio Teak Walnut
WWP	-	-	Designer White

**3 SELECT AN EDGE**

Edge Profile  
Option Not Available

**5 OPTIONS**

- DOOR**
- D2: Door Lock - \$95 per Door Set
  - D6: Delete Doors - n/c
  - D9SC: Soft Close Door Hinges - \$15 per Door
- OPEN PLAN**
- OPB: "W" "G" Style - Modify Unit for Open Plan Application - \$295
- SHELVES**
- S714F: Replace Standard Shelf with Heavy Duty Lumber 1" Shelf - \$75 per Shelf ("M" Styles - n/a)

**4 SELECT HARDWARE**

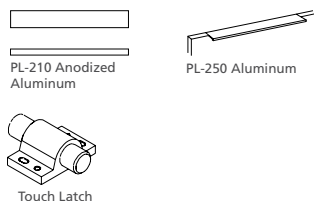

OVERHEAD BOOKCASE CONSOLE

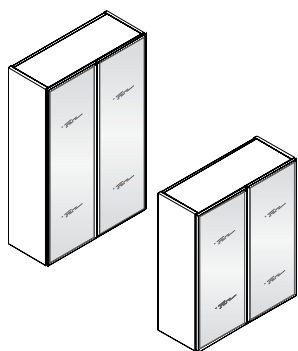

MINI-ALUMINUM FRAME FROSTED GLASS

STANDARD FEATURES

- 42" Height - 2 adjustable wood shelves
- 54" Height - 3 adjustable wood shelves
- Frosted glass resists finger prints
- Interior shelf depth 12"
- Touch latch opening / pulls not applicable
- "W" styles - 42" H units finished top, 54" H units black painted top

- units
- Unit has black back panel and is not designed for Open Plan use. Select OPB Option for Open Plan application

NOTES

- Soft close door option not available on 54"

[CLICK HERE TO VIEW PRODUCT INDEX](#)

**1 SELECT A STYLE**

DIMENSIONS		STYLE NUMBER	LIST PRICE	STYLE NUMBER	LIST PRICE	STYLE NUMBER	LIST PRICE
W" x D" x H"	WGT	"W" Veneer Top Veneer Chassis		"G" High Pressure Laminate Top Veneer Chassis		"M" Thermally Fused Laminate Top Thermally Fused Laminate Chassis	
<b>54" Height</b>							
35 x 14 x 54	130	SPC3554OH382W	3402	"G" Option N/A		"M" Option N/A	
29 x 14 x 54	120	SPC2954OH382W	3285	"G" Option N/A		"M" Option N/A	
<b>42" Height</b>							
35 x 14 x 42	120	SPC3542OH382W	2643	"G" Option N/A		"M" Option N/A	
29 x 14 x 42	110	SPC2942OH382W	2526	"G" Option N/A		"M" Option N/A	

**2 SELECT A FINISH**      **3 SELECT AN EDGE**      **5 OPTIONS**

"W" Veneer	"G" HPL	"M" TFL	
WAC	-	-	Amber Cherry
WRC	-	-	Caramel Cherry
WIC	-	-	Crimson Cherry
WEC	-	-	Ebony Cherry
WHC	-	-	Honey Cherry
WOC	-	-	KoKo Cherry
WSC	-	-	Scotch Cherry
WAM	-	-	Alabaster Maple
WCM	-	-	Clear Maple
WWM	-	-	Wheat Maple
WBO	-	-	Blush Oak
WMO	-	-	Mocha Oak
WTO	-	-	Toast Oak
WWO	-	-	Wheat Oak
WEW	-	-	Executive Walnut
WRW	GRW	-	Gray Luster Walnut
GW	-	-	Gunstock Walnut
WJW	-	-	Judicial Walnut
WNW	-	-	Natural Walnut
WTW	-	-	Studio Teak Walnut
WWP	-	-	Designer White

Edge Profile  
Option Not Available

**4 SELECT HARDWARE**

Hardware  
Option Not Available

- DOOR**  
Mini-Frame:  
- D1-40WG: White Glass - \$395 ea.  
- D2-G: Door Lock for Glass Doors - \$195 per Door Set  
- D9SC: Soft Close Door Hinges - \$15 per Door
- INTERIOR CABINET LIGHTING**  
LEDPK starter kit includes Infeed, 1 Puck Interior Light and the ability to daisy chain up to 6 total Puck Lights  
- LEDPK: LED Puck Starter Kit - \$295
- OPEN PLAN**  
- OPB: "W" "G" Style - Modify Unit for Open Plan Application - \$295
- SHELVES**  
- GS14F: Replace Standard Shelves with Glass Shelves - \$85 per Shelf  
- S714F: Replace Standard Shelf with Heavy Duty Lumber 1" Shelf - \$75 per Shelf ("M" Styles - n/a)



**FREESTANDING HALF TOWERS**

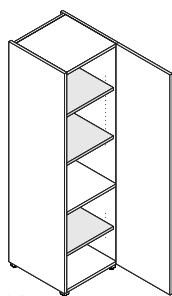

Left Hinge

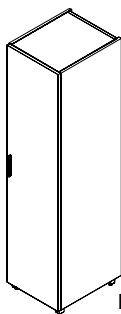

Right Hinge

**HALF WARDROBE - LEFT/RIGHT HINGE**

**STANDARD FEATURES**

- 1 fixed shelf
- 71" w/ 3 adjustable shelves
- 83" w/ 4 adjustable shelves
- Anodized aluminum feet
- Panel door w/ pull
- Wardrobe w/ coat rod & hook
- "W" styles - 71" H units finished top, 83" H units black painted top

- When ganged w/ a credenza, flush cut credenza
- Unit has black back panel and is not designed for Open Plan use. Select OPB Option for Open Plan application

**NOTES**

[CLICK HERE TO VIEW PRODUCT INDEX](#)

**1 SELECT A STYLE**

DIMENSIONS		STYLE NUMBER	LIST PRICE	STYLE NUMBER	LIST PRICE	STYLE NUMBER	LIST PRICE
W" x D" x H"	WGT	"W" Veneer Veneer Top Veneer Chassis		"G" HPL High Pressure Laminate Top Veneer Chassis		"M" TFL Thermally Fused Laminate Top Thermally Fused Laminate Chassis	
<b>Left Hinge</b>							
17.5 x 24 x 83	215	SPC1783TW283W	2881	"G" Option N/A		"M" Option N/A	
14.5 x 24 x 83	200	SPC1483TW283W	2775	"G" Option N/A		"M" Option N/A	
17.5 x 24 x 71	200	SPC1771TW283W	2321	"G" Option N/A		"M" Option N/A	
14.5 x 24 x 71	190	SPC1471TW283W	2215	"G" Option N/A		"M" Option N/A	
<b>Right Hinge</b>							
17.5 x 24 x 83	215	SPC1783TW284W	2881	"G" Option N/A		"M" Option N/A	
14.5 x 24 x 83	200	SPC1483TW284W	2775	"G" Option N/A		"M" Option N/A	
17.5 x 24 x 71	200	SPC1771TW284W	2321	"G" Option N/A		"M" Option N/A	
14.5 x 24 x 71	190	SPC1471TW284W	2215	"G" Option N/A		"M" Option N/A	

**2 SELECT A FINISH**

"W" Veneer	"G" HPL	"M" TFL	Finish
WAC	-	-	Amber Cherry
WRC	-	-	Caramel Cherry
WIC	-	-	Crimson Cherry
WEC	-	-	Ebony Cherry
WHC	-	-	Honey Cherry
WOC	-	-	KoKo Cherry
WSC	-	-	Scotch Cherry
WAM	-	-	Alabaster Maple
WCM	-	-	Clear Maple
WWM	-	-	Wheat Maple
WBO	-	-	Blush Oak
WMO	-	-	Mocha Oak
WTO	-	-	Toast Oak
WWO	-	-	Wheat Oak
WEW	-	-	Executive Walnut
WRW	GRW	-	Gray Luster Walnut
GW	-	-	Gunstock Walnut
WJW	-	-	Judicial Walnut
WNW	-	-	Natural Walnut
WTW	-	-	Studio Teak Walnut
WWP	-	-	Designer White

**3 SELECT AN EDGE**

Edge Profile  
Option Not Available

**5 OPTIONS**

**DOOR**

- D2: Door Lock - \$95 per Door
- D6: Delete Doors - n/c
- D9SC: Soft Close Door Hinges - \$15 per Door

**FEET**

- D8: Delete feet and extend fronts to floor - N/C

**GROMMETS (VERTICAL SURFACE)**

- Standard Location - \$45 ea.
- Black Plastic Vertical Surface: TM50-C (Bottom Center)
- Non-Standard Location - \$90 ea.
- Black Plastic Vertical Surface: TM50-NS

**INTERIOR CABINET LIGHTING**

- LEDPK: LED Puck Starter Kit - \$295

**OPEN PLAN**

- OPB: "W" "G" Style - Modify Unit for Open Plan Application - \$295

**4 SELECT HARDWARE**

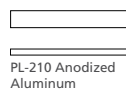

PL-210 Anodized Aluminum



PL-250 Aluminum



Touch Latch

**FREESTANDING HALF TOWERS**

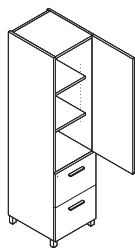

Left Hinge

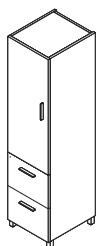

Right Hinge

**FILE/FILE/STORAGE - LEFT/RIGHT HINGE**

**STANDARD FEATURES**

- 1 fixed shelf
- 71" w/ 2 adjustable shelves
- 83" w/ 3 adjustable shelves
- Anodized aluminum feet
- Panel door w/ pull
- Wardrobe w/ coat rod & hook
- "W" styles - 71" H units finished top, 83" H units black painted top

- When ganged w/ a credenza, flush cut credenza
- Unit has black back panel and is not designed for Open Plan use. Select OPB Option for Open Plan application

**NOTES**

[CLICK HERE TO VIEW PRODUCT INDEX](#)

**1 SELECT A STYLE**

DIMENSIONS		STYLE NUMBER	LIST PRICE	STYLE NUMBER	LIST PRICE	STYLE NUMBER	LIST PRICE
W" x D" x H"	WGT	"W" Veneer Top Veneer Chassis		"G" HPL High Pressure Laminate Top Veneer Chassis		"M" TFL Thermally Fused Laminate Top Thermally Fused Laminate Chassis	
<b>Left Hinge</b>							
16 x 24 x 83	210	SPC1683TW291W	3232	"G" Option N/A		"M" Option N/A	
16 x 24 x 71	195	SPC1671TW291W	2696	"G" Option N/A		"M" Option N/A	
<b>Right Hinge</b>							
16 x 24 x 83	210	SPC1683TW292W	3232	"G" Option N/A		"M" Option N/A	
16 x 24 x 71	195	SPC1671TW292W	2696	"G" Option N/A		"M" Option N/A	

**2 SELECT A FINISH**

"W" Veneer	"G" HPL	"M" TFL	Finish
WAC	-	-	Amber Cherry
WRC	-	-	Caramel Cherry
WIC	-	-	Crimson Cherry
WEC	-	-	Ebony Cherry
WHC	-	-	Honey Cherry
WOC	-	-	KoKo Cherry
WSC	-	-	Scotch Cherry
WAM	-	-	Alabaster Maple
WCM	-	-	Clear Maple
WWM	-	-	Wheat Maple
WBO	-	-	Blush Oak
WMO	-	-	Mocha Oak
WTO	-	-	Toast Oak
WWO	-	-	Wheat Oak
WEW	-	-	Executive Walnut
WRW	GRW	-	Gray Luster Walnut
GW	-	-	Gunstock Walnut
WJW	-	-	Judicial Walnut
WNW	-	-	Natural Walnut
WTW	-	-	Studio Teak Walnut
WWP	-	-	Designer White

**3 SELECT AN EDGE**

Edge Profile  
Option Not Available

**4 SELECT HARDWARE**

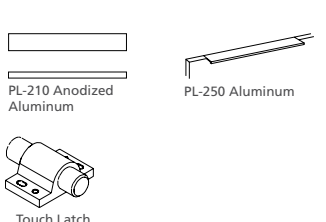

**5 OPTIONS**

- DOOR**
- D2: Door Lock - \$95 per Door
  - D6: Delete Doors - n/c
  - D9SC: Soft Close Door Hinges - \$15 per Door
- DRAWER**
- P6: Modify File/File to Box/Box/File - \$50 per pedestal
- FEET**
- D8: Delete feet and extend fronts to floor - N/C
- GROMMETS (VERTICAL SURFACE)**
- Standard Location - \$45 ea.
  - Black Plastic Vertical Surface: TM50-C (Bottom Center)
  - Non-Standard Location - \$90 ea.
  - Black Plastic Vertical Surface: TM50-NS
- INTERIOR CABINET LIGHTING**
- LEDPK starter kit includes Infeed, 1 Puck Interior Light and the ability to daisy chain up to 6 total Puck Lights
  - LEDPK: LED Puck Starter Kit - \$295
- OPEN PLAN**
- OPB: "W" "G" Style - Modify Unit for Open Plan Application - \$295

DISPLAY STORAGE TOWER

HALF TOWER - LEFT/RIGHT HINGE

STANDARD FEATURES

- .5" dia matte silver shelf rods
- 71" w/ 2 clear glass shelves
- 83" w/ 3 clear glass shelves
- Anodized aluminum feet
- Storage cabinet front edge profile/flat sides

for Open Plan use. Select OPB Option for Open Plan application

NOTES

- When ganged w/ a credenza, flush cut credenza
- Unit has black back panel and is not designed

[CLICK HERE TO VIEW PRODUCT INDEX](#)

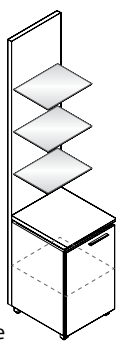

Left Hinge

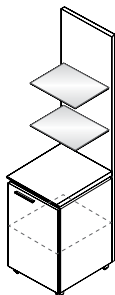

Right Hinge

1 SELECT A STYLE

DIMENSIONS		STYLE NUMBER	LIST PRICE	STYLE NUMBER	LIST PRICE	STYLE NUMBER	LIST PRICE
W" x D" x H"	WGT	"W" Veneer Veneer Top Veneer Chassis		"G" HPL High Pressure Laminate Top Veneer Chassis		"M" TFL Thermally Fused Laminate Top Thermally Fused Laminate Chassis	
<b>Left Hinge</b>							
17.5 x 24 x 83	165	SPC1783TW393W	2881	"G" Option N/A		"M" Option N/A	
17.5 x 24 x 71	145	SPC1771TW393W	2658	"G" Option N/A		"M" Option N/A	
<b>Right Hinge</b>							
17.5 x 24 x 83	165	SPC1783TW394W	2881	"G" Option N/A		"M" Option N/A	
17.5 x 24 x 71	145	SPC1771TW394W	2658	"G" Option N/A		"M" Option N/A	

2 SELECT A FINISH

"W" Veneer	"G" HPL	"M" TFL	
WAC	-	-	Amber Cherry
WRC	-	-	Caramel Cherry
WIC	-	-	Crimson Cherry
WEC	-	-	Ebony Cherry
WHC	-	-	Honey Cherry
WOC	-	-	KoKo Cherry
WSC	-	-	Scotch Cherry
WAM	-	-	Alabaster Maple
WCM	-	-	Clear Maple
WWM	-	-	Wheat Maple
WBO	-	-	Blush Oak
WMO	-	-	Mocha Oak
WTO	-	-	Toast Oak
WWO	-	-	Wheat Oak
WEW	-	-	Executive Walnut
WRW	GRW	-	Gray Luster Walnut
WGW	-	-	Gunstock Walnut
WJW	-	-	Judicial Walnut
WNW	-	-	Natural Walnut
WTW	-	-	Studio Teak Walnut
WWP	-	-	Designer White

3 SELECT AN EDGE

Edge Profile  
Option Not Available

5 OPTIONS

DOOR

- D2: Door Lock - \$95 per Door
- D6: Delete Doors - n/c
- D9SC: Soft Close Door Hinges - \$15 per Door

FEET

- D8: Delete feet and extend fronts to floor - N/C

GROMMETS (VERTICAL SURFACE)

- Standard Location - \$45 ea.
- Black Plastic Vertical Surface: TM50-C (Bottom Center)
- Non-Standard Location - \$90 ea.
- Black Plastic Vertical Surface: TM50-NS

LIGHTING

- TLR-35: Top light for full width towers - \$225
- TLR-17: Top light for half width towers - \$175

OPEN PLAN

- OPB: "W" "G" Style - Modify Unit for Open Plan Application - \$295

4 SELECT HARDWARE

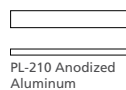

PL-210 Anodized Aluminum



PL-250 Aluminum



Touch Latch

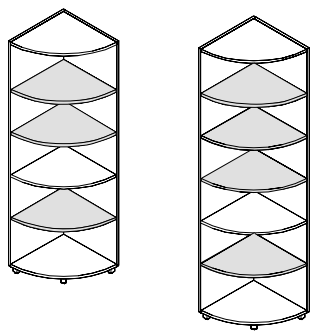

**CORNER BOOKCASE TOWER**

**STANDARD FEATURES**

- 1 fixed shelf
- 71" w/ 3 adjustable shelves
- 83" w/ 4 adjustable shelves
- Anodized aluminum feet
- Units w/ glass shelves include 1 puck interior light
- "W" styles - 71" H units finished top, 83" H units black painted top

- Fixed shelf is wood
- Shaded shelves are adjustable
- Unit has black back panel and is not designed for Open Plan use. Select OPB Option for Open Plan application

**NOTES**

[CLICK HERE TO VIEW PRODUCT INDEX](#)

**1 SELECT A STYLE**

DIMENSIONS		STYLE NUMBER	LIST PRICE	STYLE NUMBER	LIST PRICE	STYLE NUMBER	LIST PRICE
W" x D" x H"	WGT	"W" Veneer Top Veneer Chassis		"G" HPL High Pressure Laminate Top Veneer Chassis		"M" TFL Thermally Fused Laminate Top Thermally Fused Laminate Chassis	
<b>Wood Shelves</b>							
24 x 24 x 83	150	SPC2483TW298W	2545	"G" Option N/A		"M" Option N/A	
24 x 24 x 71	135	SPC2471TW298W	2321	"G" Option N/A		"M" Option N/A	
<b>Glass Shelves w/ Light</b>							
24 x 24 x 83	150	SPC2483TW299W	2911	"G" Option N/A		"M" Option N/A	
24 x 24 x 71	135	SPC2471TW299W	2633	"G" Option N/A		"M" Option N/A	

**2 SELECT A FINISH**

"W" Veneer	"G" HPL	"M" TFL	Finish
WAC	-	-	Amber Cherry
WRC	-	-	Caramel Cherry
WIC	-	-	Crimson Cherry
WEC	-	-	Ebony Cherry
WHC	-	-	Honey Cherry
WOC	-	-	KoKo Cherry
WSC	-	-	Scotch Cherry
WAM	-	-	Alabaster Maple
WCM	-	-	Clear Maple
WWM	-	-	Wheat Maple
WBO	-	-	Blush Oak
WMO	-	-	Mocha Oak
WTO	-	-	Toast Oak
WWO	-	-	Wheat Oak
WEW	-	-	Executive Walnut
WRW	GRW	-	Gray Luster Walnut
WGW	-	-	Gunstock Walnut
WJW	-	-	Judicial Walnut
WNW	-	-	Natural Walnut
WTW	-	-	Studio Teak Walnut
WWP	-	-	Designer White

**3 SELECT AN EDGE**

Edge Profile  
Option Not Available

**4 SELECT HARDWARE**

Hardware  
Option Not Available

**5 OPTIONS**

- FEET**
- D8: Delete feet and extend fronts to floor - N/C
- OPEN PLAN**
- OPB: Finished Back - \$150

**FREESTANDING FULL TOWERS**

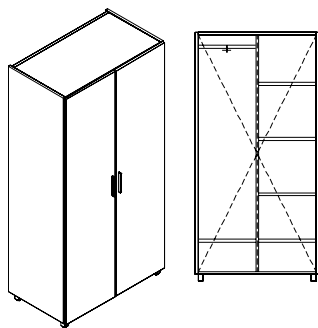

**FULL WARDROBE**

**STANDARD FEATURES**

- 2 Fixed shelves
- 71" w/ 3 adjustable shelves
- 83" w/ 4 adjustable shelves
- Anodized aluminum feet
- Panel doors w/ pulls
- Wardrobe w/ coat rod & hook
- "W" styles - 71" H units finished top, 83" H units black painted top

- When ganged w/ a credenza, flush cut credenza
- Unit has black back panel and is not designed for Open Plan use. Select OPB Option for Open Plan application

**NOTES**

[CLICK HERE TO VIEW PRODUCT INDEX](#)

**1 SELECT A STYLE**

DIMENSIONS		STYLE NUMBER	LIST PRICE	STYLE NUMBER	LIST PRICE	STYLE NUMBER	LIST PRICE
W" x D" x H"	WGT	"W" Veneer Veneer Top Veneer Chassis		"G" HPL High Pressure Laminate Top Veneer Chassis		"M" TFL Thermally Fused Laminate Top Thermally Fused Laminate Chassis	
<b>83" Height</b>							
35 x 24 x 83	315	SPC3583TW275W	4925	"G" Option N/A		"M" Option N/A	
29 x 24 x 83	275	SPC2983TW275W	4692	"G" Option N/A		"M" Option N/A	
<b>71" Height</b>							
35 x 24 x 71	265	SPC3571TW275W	4322	"G" Option N/A		"M" Option N/A	
29 x 24 x 71	225	SPC2971TW275W	4205	"G" Option N/A		"M" Option N/A	

**2 SELECT A FINISH**

"W" Veneer	"G" HPL	"M" TFL	Finish
WAC	-	-	Amber Cherry
WRC	-	-	Caramel Cherry
WIC	-	-	Crimson Cherry
WEC	-	-	Ebony Cherry
WHC	-	-	Honey Cherry
WOC	-	-	KoKo Cherry
WSC	-	-	Scotch Cherry
WAM	-	-	Alabaster Maple
WCM	-	-	Clear Maple
WWM	-	-	Wheat Maple
WBO	-	-	Blush Oak
WMO	-	-	Mocha Oak
WTO	-	-	Toast Oak
WWO	-	-	Wheat Oak
WEW	-	-	Executive Walnut
WRW	GRW	-	Gray Luster Walnut
GW	-	-	Gunstock Walnut
WJW	-	-	Judicial Walnut
WNW	-	-	Natural Walnut
WTW	-	-	Studio Teak Walnut
WWP	-	-	Designer White

**3 SELECT AN EDGE**

Edge Profile  
Option Not Available

**5 OPTIONS**

- DOOR**
- D2: Door Lock - \$95 per Door
  - D9SC: Soft Close Door Hinges - \$15 per Door
- FEET**
- D8: Delete feet and extend fronts to floor - N/C
- GROMMETS (VERTICAL SURFACE)**
- Standard Location - \$45 ea.
- Black Plastic Vertical Surface: TM50-C (Bottom Center)
  - Non-Standard Location - \$90 ea.
  - Black Plastic Vertical Surface: TM50-NS
- OPEN PLAN**
- OPB: "W" "G" Style - Modify Unit for Open Plan Application - \$295
- SHELF**
- MOD-31: Delete center partition & half shelves / Add 4 adj. shelves (83" units) or 3 adj. shelves (71" units) - \$295
  - When deleting the center partition, specify 1 D2 Door Lock per door set
  - S724F: Replace Standard Shelf with Heavy Duty Lumber 1" Shelf - \$95 per Shelf ("M" Styles - n/a)
  - S724F option applies only when MOD-31 is purchased

**4 SELECT HARDWARE**

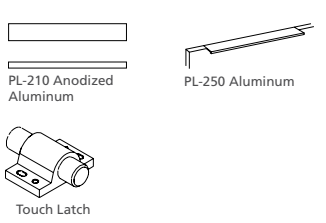

**FREESTANDING FULL TOWERS**

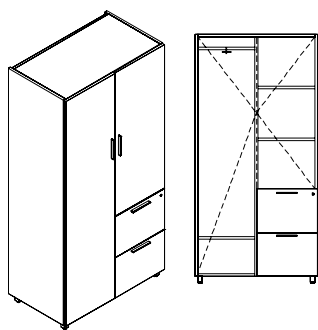

**HALF WARDROBE/FILE/FILE/STORAGE - LEFT/RIGHT HINGED**

**STANDARD FEATURES**

- 1 fixed shelf on wardrobe side
- 71" w/ 2 adjustable shelves
- 83" w/ 3 adjustable shelves
- Anodized aluminum feet
- Locking drawers
- Panel doors w/ pulls
- Wardrobe w/ coat rod & hook
- "W" styles - 71" H units finished top, 83" H units black painted top

**NOTES**

- Legal filing side to side or Letter filing front to back
- When ganged w/ a credenza, flush cut credenza
- Unit has black back panel and is not designed for Open Plan use. Select OPB Option for Open Plan application

[CLICK HERE TO VIEW PRODUCT INDEX](#)

**1 SELECT A STYLE**

DIMENSIONS		STYLE NUMBER	LIST PRICE	STYLE NUMBER	LIST PRICE	STYLE NUMBER	LIST PRICE
W" x D" x H"	WGT	"W" Veneer Veneer Top Veneer Chassis		"G" HPL High Pressure Laminate Top Veneer Chassis		"M" TFL Thermally Fused Laminate Top Thermally Fused Laminate Chassis	
<b>Wardrobe Left</b>							
35 x 24 x 83	300	SPC3583TW273W	5163	"G" Option N/A		"M" Option N/A	
35 x 24 x 71	275	SPC3571TW273W	4453	"G" Option N/A		"M" Option N/A	
<b>Wardrobe Right</b>							
35 x 24 x 83	300	SPC3583TW274W	5163	"G" Option N/A		"M" Option N/A	
35 x 24 x 71	275	SPC3571TW274W	4453	"G" Option N/A		"M" Option N/A	

**2 SELECT A FINISH**

"W" Veneer	"G" HPL	"M" TFL	
WAC	-	-	Amber Cherry
WRC	-	-	Caramel Cherry
WIC	-	-	Crimson Cherry
WEC	-	-	Ebony Cherry
WHC	-	-	Honey Cherry
WOC	-	-	KoKo Cherry
WSC	-	-	Scotch Cherry
WAM	-	-	Alabaster Maple
WCM	-	-	Clear Maple
WWM	-	-	Wheat Maple
WBO	-	-	Blush Oak
WMO	-	-	Mocha Oak
WTO	-	-	Toast Oak
WWO	-	-	Wheat Oak
WEW	-	-	Executive Walnut
WRW	GRW	-	Gray Luster Walnut
GW	-	-	Gunstock Walnut
WJW	-	-	Judicial Walnut
WNW	-	-	Natural Walnut
WTW	-	-	Studio Teak Walnut
WWP	-	-	Designer White

**3 SELECT AN EDGE**

Edge Profile  
Option Not Available

**4 SELECT HARDWARE**

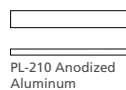

**5 OPTIONS**

**DOOR**

- D2: Door Lock - \$95 per Door
- D6: Delete Doors - n/c
- D9SC: Soft Close Door Hinges - \$15 per Door

**DRAWER**

- P6: Modify File/File to Box/Box/File - \$50 per pedestal

**FEET**

- D8: Delete feet and extend fronts to floor - N/C

**GROMMETS (VERTICAL SURFACE)**

- Standard Location - \$45 ea.
- Black Plastic Vertical Surface: TM50-C (Bottom Center)
- Non-Standard Location - \$90 ea.
- Black Plastic Vertical Surface: TM50-NS

**INTERIOR CABINET LIGHTING**

- LEDPK starter kit includes Infeed, 1 Puck Interior Light and the ability to daisy chain up to 6 total Puck Lights
- LEDPK: LED Puck Starter Kit - \$295

**OPEN PLAN**

- OPB: "W" "G" Style - Modify Unit for Open Plan Application - \$295

**SHELVES**

- S714F: Replace Standard Shelf with Heavy Duty Lumber 1" Shelf - \$75 per Shelf ("M" Styles - n/a)

**FREESTANDING FULL TOWERS**

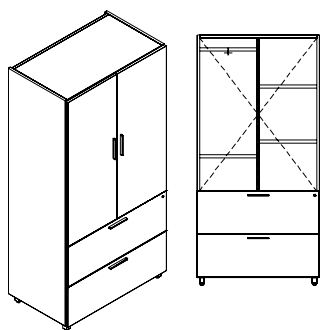

**2 LATERAL FILE/WARDROBE**

**STANDARD FEATURES**

- 71" w/ 3 adjustable shelves
- 83" w/ 4 adjustable shelves
- Anodized aluminum feet
- Locking drawers
- Panel doors w/ pulls
- Wardrobe w/ coat rod & hook
- "W" styles - 71" H units finished top, 83" H units black painted top

- Legal filing side to side or Double letter filing front to back
- When ganged w/ a credenza, flush cut credenza
- Unit has black back panel and is not designed for Open Plan use. Select OPB Option for Open Plan application

**NOTES**

[CLICK HERE TO VIEW PRODUCT INDEX](#)

**1 SELECT A STYLE**

DIMENSIONS		STYLE NUMBER	LIST PRICE	STYLE NUMBER	LIST PRICE	STYLE NUMBER	LIST PRICE
W" x D" x H"	WGT	"W" Veneer Top Veneer Chassis		"G" High Pressure Laminate Top Veneer Chassis		"M" Thermally Fused Laminate Top Thermally Fused Laminate Chassis	
<b>83" Height</b>							
35 x 24 x 83	325	SPC3583TW281W	4793	"G" Option N/A		"M" Option N/A	
29 x 24 x 83	285	SPC2983TW281W	4683	"G" Option N/A		"M" Option N/A	
<b>71" Height</b>							
35 x 24 x 71	275	SPC3571TW281W	4376	"G" Option N/A		"M" Option N/A	
29 x 24 x 71	235	SPC2971TW281W	4151	"G" Option N/A		"M" Option N/A	

**2 SELECT A FINISH**

"W" Veneer	"G" HPL	"M" TFL	Finish
WAC	-	-	Amber Cherry
WRC	-	-	Caramel Cherry
WIC	-	-	Crimson Cherry
WEC	-	-	Ebony Cherry
WHC	-	-	Honey Cherry
WOC	-	-	KoKo Cherry
WSC	-	-	Scotch Cherry
WAM	-	-	Alabaster Maple
WCM	-	-	Clear Maple
WWM	-	-	Wheat Maple
WBO	-	-	Blush Oak
WMO	-	-	Mocha Oak
WTO	-	-	Toast Oak
WWO	-	-	Wheat Oak
WEW	-	-	Executive Walnut
WRW	GRW	-	Gray Luster Walnut
GW	-	-	Gunstock Walnut
WJW	-	-	Judicial Walnut
WNW	-	-	Natural Walnut
WTW	-	-	Studio Teak Walnut
WWP	-	-	Designer White

**3 SELECT AN EDGE**

Edge Profile  
Option Not Available

**4 SELECT HARDWARE**

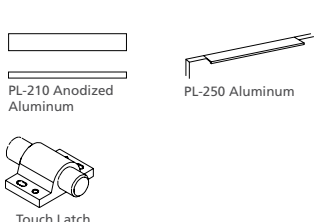

**5 OPTIONS**

- DOOR**
- D2: Door Lock - \$95 per Door
  - D6: Delete Doors - n/c
  - D9SC: Soft Close Door Hinges - \$15 per Door
- FEET**
- D8: Delete feet and extend fronts to floor - N/C
- GROMMETS (VERTICAL SURFACE)**
- Standard Location - \$45 ea.
- Black Plastic Vertical Surface: TM50-C (Bottom Center)
- Non-Standard Location - \$90 ea.
- Black Plastic Vertical Surface: TM50-NS
- INTERIOR CABINET LIGHTING**
- LEDPK starter kit includes Infeed, 1 Puck Interior Light and the ability to daisy chain up to 6 total Puck Lights
- LEDPK: LED Puck Starter Kit - \$295
- OPEN PLAN**
- OPB: "W" "G" Style - Modify Unit for Open Plan Application - \$295
- SHELVES**
- MOD-30: Delete center partition & half shelves / Add 3 full shelves (83" units) or 2 full shelves (71" units) - \$295
  - When deleting the center partition, specify 1 D2 Door Lock per door set
  - S724F: Replace Standard Shelf with Heavy Duty Lumber 1" Shelf - \$95 per Shelf ("M" Styles - n/a)
  - S724F option applies only when MOD-30 is purchased

**FREESTANDING BOOKCASES**

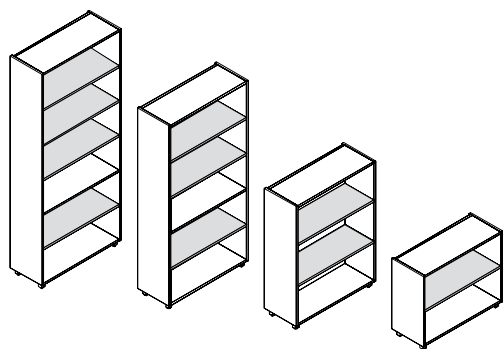

**OPEN BOOKCASES**

**STANDARD FEATURES**

- 1 fixed shelf on 83" & 71"
- Anodized aluminum feet
- Interior shelf depth 12"
- "W" styles - 29", 48", and 71" H units finished top, 83" H units black painted top

Plan application

**NOTES**

- Shaded shelves are adjustable
- Unit has black back panel and is not designed for Open Plan use. Select OPB Option for Open

[CLICK HERE TO VIEW PRODUCT INDEX](#)

**1 SELECT A STYLE**

DIMENSIONS		STYLE NUMBER	LIST PRICE	STYLE NUMBER	LIST PRICE	STYLE NUMBER	LIST PRICE
"W" x "D" x "H"	WGT	"W" Veneer Top Veneer Chassis		"G" HPL High Pressure Laminate Top Veneer Chassis		"M" TFL Thermally Fused Laminate Top Thermally Fused Laminate Chassis	
35 x 14 x 83	180	SPC3583BK250W	2551	"G" Option N/A		"M" Option N/A	
35 x 14 x 71	160	SPC3571BK250W	2321	"G" Option N/A		"M" Option N/A	
35 x 14 x 48	125	SPC3548BK250W	2102	"G" Option N/A		"M" Option N/A	
35 x 14 x 29	115	SPC3529BK250W	1597	"G" Option N/A		"M" Option N/A	
29 x 14 x 83	160	SPC2983BK250W	2418	"G" Option N/A		"M" Option N/A	
29 x 14 x 71	140	SPC2971BK250W	2078	"G" Option N/A		"M" Option N/A	
29 x 14 x 48	105	SPC2948BK250W	1742	"G" Option N/A		"M" Option N/A	
29 x 14 x 29	90	SPC2929BK250W	1256	"G" Option N/A		"M" Option N/A	

**2 SELECT A FINISH**

"W" Veneer	"G" HPL	"M" TFL	Finish
WAC	-	-	Amber Cherry
WRC	-	-	Caramel Cherry
WIC	-	-	Crimson Cherry
WEC	-	-	Ebony Cherry
WHC	-	-	Honey Cherry
WOC	-	-	KoKo Cherry
WSC	-	-	Scotch Cherry
WAM	-	-	Alabaster Maple
WCM	-	-	Clear Maple
WWM	-	-	Wheat Maple
WBO	-	-	Blush Oak
WMO	-	-	Mocha Oak
WTO	-	-	Toast Oak
WWO	-	-	Wheat Oak
WEW	-	-	Executive Walnut
WRW	GRW	-	Gray Luster Walnut
GW	-	-	Gunstock Walnut
WJW	-	-	Judicial Walnut
WNW	-	-	Natural Walnut
WTW	-	-	Studio Teak Walnut
WWP	-	-	Designer White

**3 SELECT AN EDGE**

Edge Profile  
Option Not Available

**5 OPTIONS**

**FEET**

- D8: Delete feet and extend fronts to floor - N/C

**INTERIOR CABINET LIGHTING**

- LEDPK starter kit includes Infeed, 1 Puck Interior Light and the ability to daisy chain up to 6 total Puck Lights
- LEDPK: LED Puck Starter Kit - \$295

**OPEN PLAN:**

- OPB: Finished Back - \$150

**SHELF**

- G514F: Replace Standard Shelves with Glass Shelves - \$85 per Shelf
- S714F: Replace Standard Shelf with Heavy Duty Lumber 1" Shelf - \$75 per Shelf ("M" Styles - n/a)

**4 SELECT HARDWARE**

Hardware  
Option Not Available



**BASE MODIFICATIONS**

**RUNOFF SLEIGH BASE**

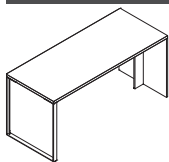

STYLE NUMBER	LIST PRICE	SPECIFICATIONS
<b>24" Metal Sleigh Base</b> SSB24	450	- Metal Sleigh base - standard in silver finish
<b>30" Metal Sleigh Base</b> SSB30	475	
<b>36" Metal Sleigh Base</b> SSB36	495	

Available: - Central, NOT SO square, Spaces

**COMPUTER SUPPORT**

**DELUXE SINGLE MONITOR ARM W/ USB POST**



STYLE NUMBER	LIST PRICE	SPECIFICATIONS
MA1952	495	- (4) 2.0 USB Ports - Post Length: 22-1/2"H, Post Base Requires 80mm Dia. Hole - Spring Assist - Full Movement Arm, Arm Extends Up To 13 - 3/8" - Supports Screens Up To 24", Swivels 180 degrees - Mount Plate Tilts 85 degrees - Arm: Die Cast Aluminum

**Notes**  
- Surface Factory Bored / Ready To Install

Available: - All DARRAN Collections

**COMPUTER SUPPORT**

**DELUXE DOUBLE MONITOR ARM W/ USB POST**



STYLE NUMBER	LIST PRICE	SPECIFICATIONS
MA2952	795	- (4) 2.0 USB Ports - Post Length: 22-1/2"H, Post Base Requires 80mm Dia. Hole - Spring Assist - Full Movement Arm, Arm Extends Up To 13 - 3/8" - Supports Screens Up To 24", Swivels 180 degrees - Mount Plate Tilts 85 degrees - Arm: Die Cast Aluminum

**Notes**  
- Surface Factory Bored / Ready To Install  
- Can Accommodate Up To 4 Monitors By Ordering Extra Double Arms.  
1 Extra Arm and 1 Double Clamp - Add\$305

Available: - All DARRAN Collections

**COMPUTER SUPPORT**

**CPU RETRACTABLE CRADLE**

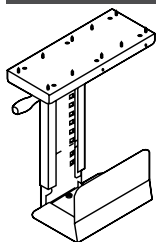

STYLE NUMBER	LIST PRICE	SPECIFICATIONS
K18	195	- Black Metal CPU Carriage - Full 360° swivel capability allows easy access to rear of CPU for cables / wires - Track allows 8- 1/2" extension - Width Adjustment 5-1/2" to 9-1/4" - Height adjustment 14- 5/8" to 20- 1/2" - Black epoxy finish

**Notes**  
- Factory Installed

Available: - All DARRAN Collections

COMPUTER SUPPORT

ARTICULATING KEYBOARD TRAY

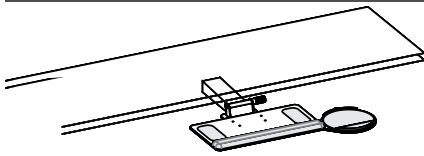

STYLE NUMBER

*Factory Installed*

K28

*Field Installed*

K28F

LIST PRICE

375

395

SPECIFICATIONS

- Adjusts effortlessly - A simple one-handed motion allows the keyboard to be repositioned instantly, without the use of locks or levers
- Encourages low-risk postures - Maximizes adjustability within a safe operating range.
- Will last a lifetime - Exceeds all applicable BIFMA Standards and comes with a lifetime guarantee.

Notes

- Factory Installed (standard)
- FIELD INSTALL - \$395

Available: - All DARRAN Collections

COMPUTER SUPPORT

TRADITIONAL PULL-OUT DRAWER WITH KEYBOARD TRAY

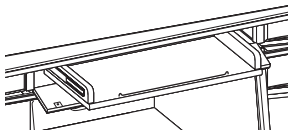

STYLE NUMBER

K21

LIST PRICE

450

SPECIFICATIONS

- Traditional Pull-out Drawer w/Keyboard Tray

Available: - Jamestown

CONFERENCE DESK SUPPORT POST OPTIONS

WOOD DRUM



STYLE NUMBER

*6" Diameter Drum*

B6

LIST PRICE

395

SPECIFICATIONS

- Available in Walnut / Cherry / Maple
- Adjustable levelers
- Replaces standard metal round legs

Notes

- Specify Finish

Available: - Central Park, NOT SO square

CONFERENCE DESK SUPPORT POST OPTIONS

WOOD HALF DRUM

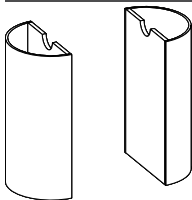

STYLE NUMBER

*8" Half Drum*

HC08

*16" Diameter Drum*

HC16

LIST PRICE

695

895

SPECIFICATIONS

- Available in Walnut / Cherry / Maple
- Adjustable levelers

Notes

- Specify Finish

Available: - Central Park, NOT SO square, Richmond Park

CONFERENCE DESK SUPPORT POST OPTIONS

METAL OVAL "T" BASE

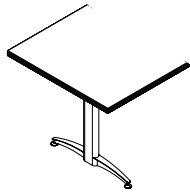

STYLE NUMBER

*Silver*

32MOTS

*Black*

32MOTB

LIST PRICE

595

595

SPECIFICATIONS

- 3" x 1" Aluminum square extrusion
- Leveler adjustment
- Oval Post

Available: - Silver or Black

DOOR MODIFICATIONS

SOFT CLOSE DOOR HINGE



STYLE NUMBER

D9SC

LIST PRICE

15 Per Door

SPECIFICATIONS

- Snap onto standard door hinge
- Requires (1) per door
- Max door height 43"
- Factory installed where specified
- Individually shipped for field installation

Notes

- Specify Each Item To Have Slow Close Feature

Available: - All DARRAN Collections

DOOR MODIFICATIONS

DELETE DOORS

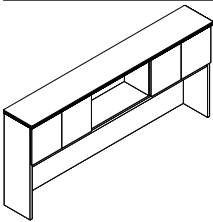

STYLE NUMBER

D6

LIST PRICE

N/C

SPECIFICATIONS

- Standard Door overheads and cabinets can have door deleted for open access. Modification of hinge rails and structural components are made face ready.

Available: - All DARRAN Collections

DOOR MODIFICATIONS

- REPLACE GLASS PANEL INSERT WITH VENEER PANEL INSERT



Glass Door

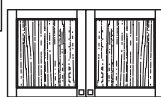

Wood Door

STYLE NUMBER

D35

LIST PRICE

30 per door

SPECIFICATIONS

- Replace glass panel insert with veneer panel insert

Notes

- Not Available on "M" skus
- Glass door has beveled glass
- Wood door w/ veneer insert - only available on "W" style

Available: - Capitol Park, Jamestown, Prado, Richmond Park

**DOOR MODIFICATIONS**

**DELETE DOORS/REPLACE BLACK LAMINATE SHELF W/ FINISHED SHELF**

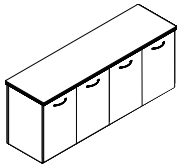

**STYLE NUMBER**  
D6A

**LIST PRICE**  
N/C

**SPECIFICATIONS**  
- Delete doors and replace black laminate shelf with finished shelf

Available: - All Storage Credenzas ("W"/"G" Styles ).  
Excludes Rail.

**DOOR MODIFICATIONS**

**PANEL DOOR LOCK**

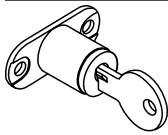

**STYLE NUMBER**  
D2

**LIST PRICE**  
95 Per Door Set

**SPECIFICATIONS**  
- Door Locks - 1 Door w/ Lock, Other Door w/ Catch Latch  
- Contact Customer Service regarding limited lock locations and keying.

Available: - Panel Doors, Wood Frame Doors, and Silverluma doors

**DOOR MODIFICATIONS**

**GLASS DOOR LOCK**

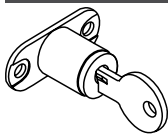

**STYLE NUMBER**  
D2-G

**LIST PRICE**  
195 Per Door Set

**SPECIFICATIONS**  
- Door Locks - 1 Door w/ Lock, Other Door w/ Catch Latch  
- Contact Customer Service regarding limited lock locations and keying.

Available: - Glass Doors

**DOOR MODIFICATIONS**

**BOX DRAWER ACCESSORIES**

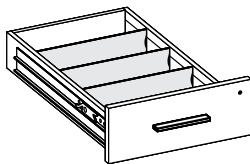

**STYLE NUMBER**  
*Wood Drawer Dividers w/ Clips*  
K-DIV  
*Single Tray - Utility Tray*  
K-Sut

**LIST PRICE**  
SET OF 3 - 30  
30 each

**SPECIFICATIONS**  
- K-DIV Extra Wood Drawer Dividers with Clips, Top Box drawers standard with 1 divider  
- K-SUT Single Tray - Utility Tray, Specify Legal or Letter drawer width

Available: - All DARRAN Collections. Excludes Rail.

**DRAWER OPTIONS**

**TRADITIONAL CENTER DRAWER**

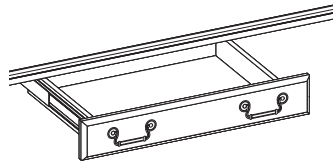

**STYLE NUMBER**  
K17  
*Add Skirt Option*  
K17-SK

**LIST PRICE**  
225  
  
325

**SPECIFICATIONS**  
- Standard on desks in Jamestown Collection. Optional center drawers available for bullet conference desk, kneespace credenzas and corner units. 3 ply hardwood drawer / dowel construction profile shaped drawer front. Specify pull choice.

Available: - Jamestown

**DRAWER OPTIONS**

**FINISHED TRADITIONAL CENTER DRAWER**

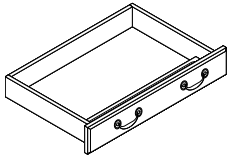

**STYLE NUMBER**  
K30  
*Add Skirt Option*  
K30-SK

**LIST PRICE**  
195  
  
295

**SPECIFICATIONS**  
- Veneer drawer front finished to match unit veneer. Edges are scalloped to match standard drawers.  
- Standard with matching wood grain pencil tray  
- Pulls selected to match unit installed

Available: - Richmond Park

**DRAWER OPTIONS**

**FINISHED CENTER DRAWER**

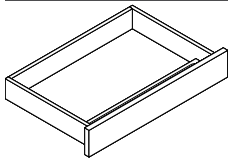

**STYLE NUMBER**  
K31  
*Add Skirt Option*  
K31-SK

**LIST PRICE**  
195  
  
295

**SPECIFICATIONS**  
- Veneer drawer front finished to match unit W or G style veneer.  
- Ball bearing smooth operation  
- Drawer has lifetime guarantee  
- Standard with matching wood grain pencil tray  
- Laminate drawer front to match laminate unit (M style)

Available: - Central Park, NOT SO square, Rail

**DRAWER OPTIONS**

**PRADO/SPACES CENTER DRAWER - VENEER BOTTOM**

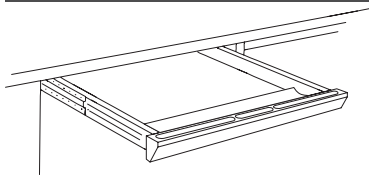

**STYLE NUMBER**  
*Factory Installed*  
K1  
*Field Installed*  
K1BVF

**LIST PRICE**  
275  
  
275

**SPECIFICATIONS**  
- Solid hardwood front beveled and rounded with recessed pencil tray.

Available: - Prado, Spaces

**DRAWER OPTIONS**

**CENTER DRAWER**

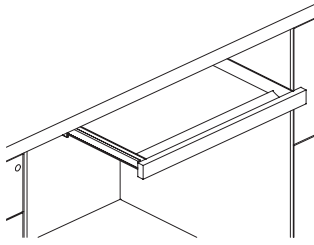

**STYLE NUMBER**

**LIST PRICE**

**SPECIFICATIONS**

*Factory Installed*

- Center Drawer - Factory Installed, Center Drawer - Field Installed

K1R

275

*Field Installed*

K1RF

275

Available: - Rift

**DRAWER OPTIONS**

**CENTER DRAWER WITH SKIRT**

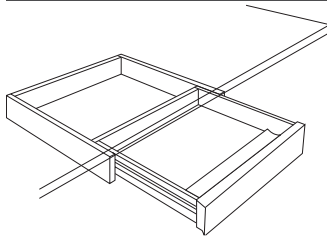

**STYLE NUMBER**

**LIST PRICE**

**SPECIFICATIONS**

*Factory Installed*

- Center Drawer - Factory Installed, Center Drawer - Field Installed

K2R

375

*Field Installed*

K2RF

375

*Add Skirt Option*

K2R-SK

475

Available: - Rift

**DRAWER OPTIONS - BOTTOM COVER**

**BLACK DURA-LEATHER DRAWER BOTTOM COVERS**

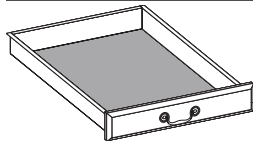

**STYLE NUMBER**

**LIST PRICE**

**SPECIFICATIONS**

P2

75

- Center drawer and Box/Tray drawers are covered in Black Duraleather that adds a prestigious touch.

Available: - Jamestown

**DRAWER OPTIONS - BOTTOM COVER**

**FELT BOTTOM CENTER DRAWER INSERT LINER**

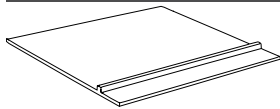

**STYLE NUMBER**

**LIST PRICE**

**SPECIFICATIONS**

K3

95

- Inserts into center drawer and features divider for open pen and pencil storage. Removable for easy cleaning.  
 - Adds a luxurious touch to center drawers.  
 - Color: Dark Brown Coal

Available: - All DARRAN Collections. Excludes Rail.

**DRAWER OPTIONS - UPGRADE**

**WOOD DRAWER UPGRADE**

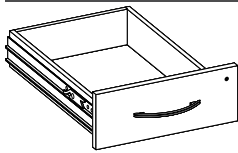

**STYLE NUMBER**  
P33

**LIST PRICE**  
40 Per Drawer

**SPECIFICATIONS**

- Dowel joint construction
- Hardwood veneer multi-ply drawer
- UV finish
- 1/4" Wood veneer bottoms
- File drawer bottoms are five block reinforced for heavy weight capacity
- Lifetime guaranteed

Available: - Central Park, Capitol Park, NOT SO square, Rail, Richmond Park

**LIGHTING**

**LT-LED TASK LIGHT**

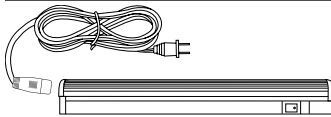

**STYLE NUMBER**  
*24" Tasklight*  
LT-LED24  
*48" Tasklight*  
LT-LED48  
*60" Tasklight*  
LT-LED60  
*Linking Cable*  
LC22

**LIST PRICE**  
90  
165  
180  
20

**SPECIFICATIONS**

- Anodized aluminum finish
- Tilting beam allows adjustability
- Switch with dimming control
- 50,000 hour life
- 12V power drive standard with each task light 30 watt max

**Notes**

- LC22: 20" LT-LED Task light linking cable

Available: - All DARRAN Collections

**LIGHTING**

**DELETE TASK LIGHT CONCEALMENT APRON RAIL**

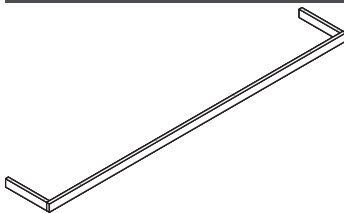

**STYLE NUMBER**  
WAR-D

**LIST PRICE**  
Deduct 125

**SPECIFICATIONS**

- Delete Tasklight Concealment apron rail when a task light is not used on a wall hung unit

Available: - Wall Hung Units

**LIGHTING**

**SLIM LINE ALUMINUM LED TASK LIGHT**

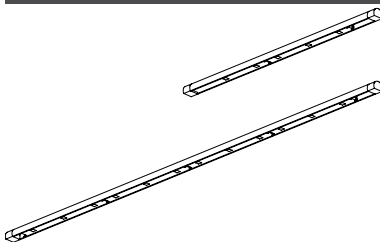

**STYLE NUMBER**  
*24" Tasklight*  
LED24  
*48" Tasklight*  
LED48  
*60" Tasklight*  
LED60  
*Linking Package*  
DPC

**LIST PRICE**  
315  
445  
555  
Deduct 85 per task light

**SPECIFICATIONS**

- Anodized aluminum finish
- Tilting beam allows adjustability
- Switch with dimming control
- 50,000 hour life
- 12V power drive standard with each task light 30 watt max

**Notes**

- Link multiple tasklights up to 30W of power wattage. Deletes 1 power drive

Available: - Rift and Spaces

**LIGHTING**

**LED INTERIOR CABINET PUCK LIGHT**

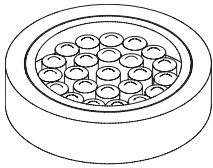

**STYLE NUMBER**

**LIST PRICE**

**SPECIFICATIONS**

**Starter Kit**  
LEDPK  
**1 LED Interior Puck Light**  
PK

295  
  
125

- Starter kit includes Infeed, 1 Puck Interior Light and the ability to daisy chain up to 6 total Puck Lights
- (1) LED Puck Light with 30W power drive and switch
- Recessed fixture
- 12V linking cord 98"L
- Silver finish
- 50,000 hour life
- 2 watt per light

**Notes**

- Power drive included, Light only

Available: - Overhead/Tower Units with glass doors or no doors

**PEDESTAL MODIFICATIONS**

**BREAKFRONT PEDESTAL WITH WIRE MANAGEMENT CAVITY DOOR**

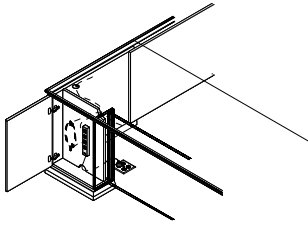

**STYLE NUMBER**

**LIST PRICE**

**SPECIFICATIONS**

PC10  
**Power Supply Cordset**  
PD717

95  
  
95

- Hinged pedestal front door offers easy access for wire management
- Wire hooks provide wire coil storage
- Wire access openings allow access to floor, cabinets interior and kneespace
- Cabinet interior is black finish
- Top grommet is positioned over cavity for access ease
- (Power Strip Optional)

**Notes**

- Breakfront Chassis Only

Available: - All DARRAN Collections. Excludes Jamestown, Rail, Richmond, and Rift.

**PEDESTAL MODIFICATIONS**

**BLACK LAMINATE PRINTER PULLOUT BOTTOM SHELF**

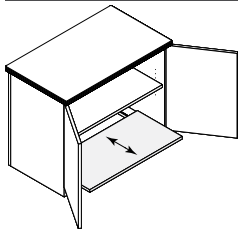

**STYLE NUMBER**

**LIST PRICE**

**SPECIFICATIONS**

PPOS

214

- Black Laminate pullout shelf on suspension
- Black grommet
- Adjustable Shelf

Available: - All DARRAN Collections. Excludes Rail.

**PEDESTAL MODIFICATIONS**

**ADD VENEER KNEESPACE CABINETS - BASE**

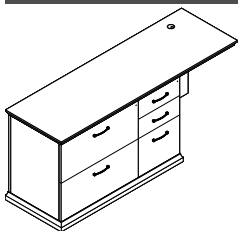

**STYLE NUMBER**

**LIST PRICE**

**SPECIFICATIONS**

**Add Box/Box/File or File/File**

P40B

985

- Multi-file specify Box/Box Left or Right

**Add Lateral File 29" W**

P41B

1205

**Notes**

- Add additional Standard Cabinets To Kneespace Area.

**Add Multi-File - 31"W**

P42B

1205

**Add Storage With Doors 29"W**

P43B

1095

**Add CPU /Printer Cabinet - Open**

P44B

1095

Available: - Capitol Park, Jamestown, Prado, Richmond Park



**PEDESTAL MODIFICATIONS**

**ADD VENEER KNEESPACE CABINETS - NO BASE**

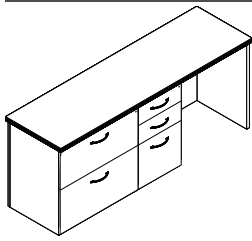

Available: - Central Park, NOT SO square

STYLE NUMBER	LIST PRICE
<i>Add Box/Box/File or File/File</i> P40W	875
<i>Add Lateral File 29" W</i> P41W	985
<i>Add Multi-File - 31"W</i> P42W	1095
<i>Add Storage With Doors 29"W</i> P43W	985
<i>Add CPU /Printer Cabinet - Open</i> P44W	985

**SPECIFICATIONS**  
- Multi-file specify Box/Box Left or Right

**Notes**  
- Add additional Standard Cabinets To Kneespace Area.

**PEDESTAL MODIFICATIONS**

**ADD TECH VENEER KNEESPACE CABINETS - NO BASE**

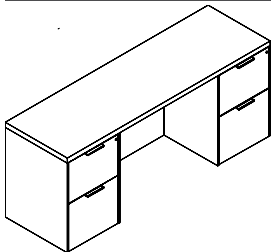

Available: - Rift

STYLE NUMBER	LIST PRICE
<i>Add Box/Box/File or File/File</i> P40T	1100
<i>Add Lateral File 29" W</i> P41T	1210
<i>Add Multi-File - 31"W</i> P42T	1320
<i>Add Storage With Doors 29"W</i> P43T	1210
<i>Add CPU /Printer Cabinet - Open</i> P44T	1210

**SPECIFICATIONS**  
- Multi-file specify Box/Box Left or Right

**Notes**  
- Add additional Standard Cabinets To Kneespace Area.

**PEDESTAL MODIFICATIONS**

**ADD MELAMINE (TFL) KNEESPACE CABINETS - NO BASE**

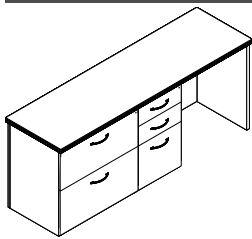

Available: - Central Park (TFL) and NOT SO square (TFL)

STYLE NUMBER	LIST PRICE
<i>Add Box/Box/File or File/File</i> P40M	688
<i>Add Lateral File 29" W</i> P41M	853
<i>Add Multi-File - 31"W</i> P42M	963
<i>Add Storage With Doors 29"W</i> P43M	765
<i>Add CPU /Printer Cabinet - Open</i> P44M	875

**SPECIFICATIONS**  
- Multi-file specify Box/Box Left or Right

**Notes**  
- Add additional Standard Cabinets To Kneespace Area.

**PEDESTAL MODIFICATIONS**

**MODIFY DRAWER CONFIGURATIONS**

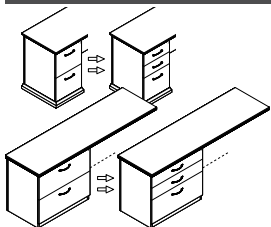

Available: - All DARRAN Collections. Excludes Rail.

STYLE NUMBER	LIST PRICE
<i>File/File to Box/Box/File</i> P6	50 per pedestal
<i>Box/Box/File to File/File</i> P6	50 per pedestal
<i>Lateral File to 2 Box Drawers</i> P8	95 per pedestal

**SPECIFICATIONS**  
- Modify File/File To Box/Box/File - Any Unit

**PEDESTAL MODIFICATIONS**

**MODIFY DRAWER CONFIGURATIONS**

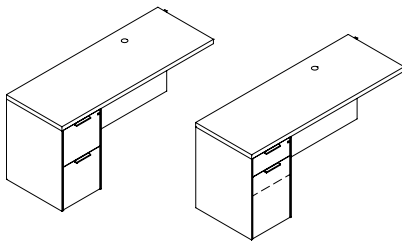

**STYLE NUMBER**

*File/File to Box/Box/File*

P6H

*Lateral File to 2 Box Drawers*

P8

**LIST PRICE**

95 per pedestal

95 per pedestal

**SPECIFICATIONS**

- Modify File/File To Box/Hidden Box/File - Any Unit

Available: - Rift

**POWER / DATA**

**POWER SUPPLY CORDSET**

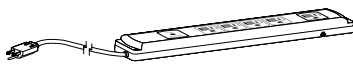

**STYLE NUMBER**

PD717

**LIST PRICE**

95

**SPECIFICATIONS**

- SIZE: 10.75"L x 2.0"W x 1.06"H

- (5) Outlets w/ 10' cord

- Surge suppression (720 Joules)

- 15 Amp breaker

- Available on: Vertical Panels, Cabinet Interiors, and under tops

Available: - All DARRAN Collections

**PRODUCT MODIFICATIONS**

**MODIFY WIDTH - OPEN KNEESPACE**

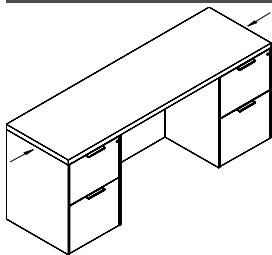

**STYLE NUMBER**

MOD-1

**LIST PRICE**

125

**SPECIFICATIONS**

- Modify width down on any unit with an open kneespace: desk, workstation credenza, bridge, return

Available: - All DARRAN Collections

**PRODUCT MODIFICATIONS**

**MODIFY WIDTH - OPEN/CLOSED STORAGE**

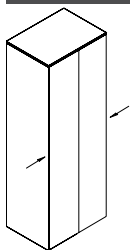

**STYLE NUMBER**

MOD-2

**LIST PRICE**

250

**SPECIFICATIONS**

- Modify width down on any unit with open or closed storage section: overheads, wall hung units, storage credenzas, towers

Available: - All DARRAN Collections

**PRODUCT MODIFICATIONS** *MODIFY WIDTH - OUTSIDE OF MOD-1, MOD-2*

STYLE NUMBER	LIST PRICE	SPECIFICATIONS
MOD-3	Contact Factory for Pricing	- Width modification outside of MOD-1 & MOD-2

Available: - All DARRAN Collections

**PRODUCT MODIFICATIONS** *MODIFY WIDTH - TACKBOARD, SLAT WALL, VENEER PANEL, OR A GLASSBOARD*

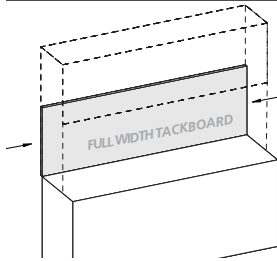

STYLE NUMBER	LIST PRICE	SPECIFICATIONS
MOD-4	50	- Modify width down on tackboard, slat wall, veneer panel, or a overhead glassboard

Available: - All DARRAN Collections

**PRODUCT MODIFICATIONS** *MODIFY DEPTH - DECREASE DEPTH*

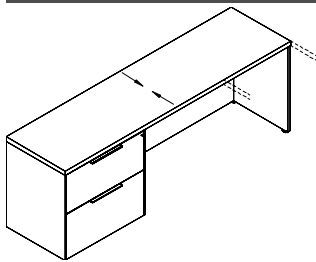

STYLE NUMBER	LIST PRICE	SPECIFICATIONS
MOD-5	125	- Modify depth down (minimum depth for a unit with drawers is 21"D)
		<b>Notes</b> - Ex. 24" to 21", 30" to 24", and 36" to 30"

Available: - All DARRAN Collections

**PRODUCT MODIFICATIONS** *MODIFY DEPTH - INCREASE DEPTH*

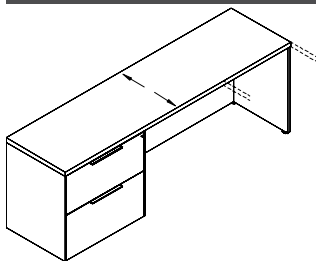

STYLE NUMBER	LIST PRICE	SPECIFICATIONS
MOD-6	Add 10%	- Increase depth
		<b>Notes</b> - Ex. 24" to 30", 30" to 36", and 36" to 42"

Available: - All DARRAN Collections. Excludes Rift.

**PRODUCT MODIFICATIONS**

**MODIFY HEIGHT**

STYLE NUMBER	LIST PRICE	SPECIFICATIONS
MOD-7	Contact Factory for Pricing	- Modify height of a unit

Available: - All DARRAN Collections

**PRODUCT MODIFICATIONS**

**MODIFY CONFERENCE TABLE LENGTH AND WIDTH - 1 PIECE TOP**

STYLE NUMBER	LIST PRICE	SPECIFICATIONS
MOD-8	125	- Modify length/width down on a 1 piece table top

Available: - Conferencing

**PRODUCT MODIFICATIONS**

**MODIFY CONFERENCE TABLE LENGTH AND WIDTH - 2/3 PIECE TOP**

STYLE NUMBER	LIST PRICE	SPECIFICATIONS
MOD-9	250	- Modify length/width down on a 2 or 3 piece table top

Available: - Conferencing

**REFRIGERATOR MODIFICATION**

**REFRIGERATOR CABINET MODIFICATION**

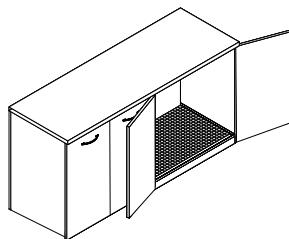

STYLE NUMBER	LIST PRICE	SPECIFICATIONS
REF01	195	- Open back cutout for venting - Moisture sponge mat - Contaminate ledge - Contact customer service for maximum refrigerator size (Changes based on unit).

Available: - Storage Credenzas

**SHAPED TOPS** **OVERHEAD/WALL HUNG SHAPED TOP**

STYLE NUMBER	LIST PRICE	SPECIFICATIONS
<b>99"W - 105"W</b>		- Shaped tops for overheads and wall hungs
TOH-1	405	
<b>58"W - 93"W</b>		
TOH-2	315	
<b>29"W - 47"W</b>		
TOH-3	203	

Available: - Central Park, Rail

**SHAPED TOPS** **BOOKCASE SHAPED TOP**

STYLE NUMBER	LIST PRICE	SPECIFICATIONS
<b>29"W - 35"W x 15"D</b>		- 15" D Shaped tops for bookcases
TOH-4	203	- Shaped on front

Available: - Central Park, Rail

**SHAPED TOPS** **TOWER SHAPED TOP**

STYLE NUMBER	LIST PRICE	SPECIFICATIONS
<b>16" Single Width Tower</b>		- 24" deep shaped tops for towers
TOH-5	158	- Shaped on front
<b>29"W - 46"W Tower</b>		
TOH-6	203	

Available: - Central Park, Rail

**SHAPED TOPS** **WORKSURFACE SHAPED TOP**

STYLE NUMBER	LIST PRICE	SPECIFICATIONS
<b>Shape Four Sides</b>		- S4S Applies to desk, bridge or any freestanding unit. This adds shapes or copes to two sides (desk, bridges) or one side and back of units (returns).
S4S	50	
<b>Shape Three Sides</b>		- S3S Applies to credenza units. This adds shapes to the two sides.
S3S	50	- Credenzas are shaped front standard with flat back
		<b>Notes</b>
		- Desk, Freestanding and Credenza units will grow 1" in width due to adding shapes on ends of units.

Available: - Central Park

**SHAPED TOPS** **PREMIUM EDGE - SHAPED WORKSURFACE TOP**

STYLE NUMBER	LIST PRICE	SPECIFICATIONS
<i>Shape Four Sides Premium Edge</i>		
S4S-PE	Add 10%	- S4S-PE Applies to desk, bridge or any freestanding unit. This adds shapes or copes to two sides (desk, bridges) or one side and back with hardwood rims (returns).
<i>Shape Three Sides Premium Edge</i>		
S3S-PE	Add 10%	- S3S-PE Shape Three Sides Premium Edge. Applies to credenza units. This adds shape to the two sides with hardwood rims.

\* 10% Upcharge includes 5% for premium edge

**Notes**  
- Desk, Freestanding and Credenza units will grow 1" in width due to adding shapes on ends of units.

Available: - Central Park

**SHELF MODIFICATIONS** **GLASS SHELVES - TEMPERED FULL WIDTH 26" - 35"**

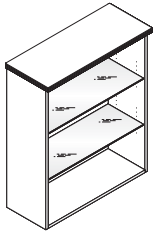

STYLE NUMBER	LIST PRICE	SPECIFICATIONS
<i>26"W - 35"W x 14"D Shelf</i>		
GS14F	85	- Glass Shelves Replace Wood Shelf In Open Or Glass Door Cabinet. Also Order Interior Cabinet Lighting.

Available: - All DARRAN Collections

**SHELF MODIFICATIONS** **TEMPERED GLASS SHELVES FOR HALF CABINET 17- 1/2" WIDTHS**

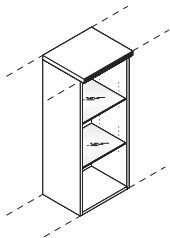

STYLE NUMBER	LIST PRICE	SPECIFICATIONS
<i>14-1/2"W - 17- 1/2"W x 14"D Shelf</i>		
GS14H	65 ea	- Glass Shelves Replace Wood Shelf In Open Or Glass Door Cabinet. Also Order Interior Cabinet Lighting.

**Notes**  
- Replace only adjustable shelves between cabinet light and fixed lower wood shelf.

Available: - All DARRAN Collections

**SHELF MODIFICATIONS** **CURVED CORNER GLASS SHELF**

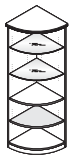

STYLE NUMBER	LIST PRICE	SPECIFICATIONS
GS14CC	85 ea	- Curved shelves feature glass retainer clips to prevent tipping

**Notes**  
- Replace only adjustable shelves between cabinet light and fixed lower wood shelf.

Available: - All DARRAN Collections. Excludes Rail.

**SHELF MODIFICATIONS**

**HEAVY DUTY SOLID WOOD BOOKCASE REPLACEMENT SHELVES**

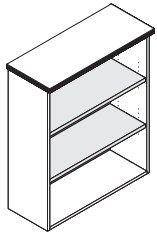

**STYLE NUMBER**  
**1" Wood Shelf 14" Deep**  
 S714F  
**1" Wood Shelf 24" Deep**  
 S714FX

**LIST PRICE**  
 75 ea  
 150 each

**SPECIFICATIONS**  
 - 1" Solid Lumber Core Shelves Replace Standard 3/4" Plywood  
 Adjustable And Fixed Shelves

Available: - All DARRAN Collections. Excludes Rail.

**SLAT WALL ACCESSORIES**

**SLAT WALL ACCESSORY TRAY**

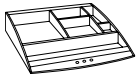

**STYLE NUMBER**  
 SWA9

**LIST PRICE**  
 45

**SPECIFICATIONS**  
 - Specify Black Or Matte Silver

Available: - All DARRAN Collections. Excludes Rail.

**SLAT WALL ACCESSORIES**

**SLAT WALL FOLDER TRAY**



**STYLE NUMBER**  
 SWA7

**LIST PRICE**  
 45

**SPECIFICATIONS**  
 - Specify Black Or Matte Silver

Available: - All DARRAN Collections. Excludes Rail.

**SLAT WALL ACCESSORIES**

**SLAT WALL PAPER TRAY**



**STYLE NUMBER**  
 SWA2

**LIST PRICE**  
 35

**SPECIFICATIONS**  
 - Specify Black Or Matte Silver

Available: - All DARRAN Collections. Excludes Rail.

SLAT WALL ACCESSORIES

SLAT WALL PENCIL HOLDER



**STYLE NUMBER**  
SWA4

**LIST PRICE**  
25

**SPECIFICATIONS**  
- Specify Black Or Matte Silver

Available: - All DARRAN Collections. Excludes Rail.

SPECIALTY VENEER ACCENTS

BLACK EBONY WOOD INLAY IN ONE PIECE CONFERENCE TOP

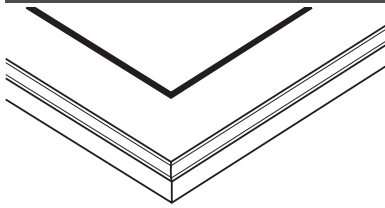

**STYLE NUMBER**  
*One Piece Conference Top*  
T30  
*Two Piece Conference Top*  
T31

**LIST PRICE**  
735  
1480

**SPECIFICATIONS**  
- Standard veneer top is routed for Ebony wood inlay 1/8" x 3/16" width line. Inlay wood is miter jointed in the corners, hand fitted, glued and sanded flush with top veneer. Inlay forms a 3" border to top edge

**Notes**  
- Hand fitted miter corner Black Ebony wood inlay installed in standard wood veneer tops

Available: - Conferencing Tops.

SPECIALTY VENEER ACCENTS

BLACK/WHITE/BLACK WOOD INLAY

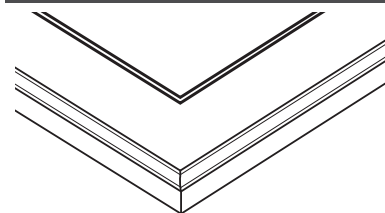

**STYLE NUMBER**  
*One Piece Top*  
T30BWB  
*Two Piece Top*  
T31BWB

**LIST PRICE**  
950  
1795

**SPECIFICATIONS**  
- Standard veneer top is routed for wood inlay 1/8" x 3/16" width line. Each color is 1/16" wide. White inlay line is finished over providing a subtle contrast to line detail

**Notes**  
- Hand fitted miter corner ebony-maple-ebony wood inlay installed in standard veneer top  
- The center white line can be masked off preventing color stains from penetrating. Final top coats are applied over the white line.

Available: - Conferencing Tops

SPECIALTY VENEER ACCENTS

BLACK EBONY WOOD INLAY W/ WOOD FAN DETAIL - 1 PIECE CONFERENCE TABLE TOP

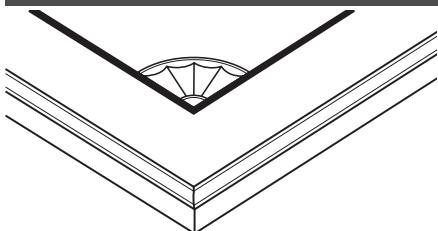

**STYLE NUMBER**  
*One Piece Top*  
T51  
*Two Piece Top*  
T52

**LIST PRICE**  
1160  
2110

**SPECIFICATIONS**  
- Standard veneer top is routed for wood inlay 1/8" x 3/16" width line. With each 90 degree corner routed for Quarter circle fan inlays. Inlay fans combined with solid black inlay preserves an old traditional appearance. Fans are handcrafted from teakwood, rosewood, mahogany, and other exotic woods. Each piece of veneer is shaded by burning and is hand fitted to a perfect fan shape - truly and old world craft  
- Conference tables: 4 fans, one in each corner per top section

**Notes**  
- Hand fitted miter corner wood inlay and fan installed in standard veneer top  
- Only available on square/ rectangle tops

Available: - Conferencing Tops



**SPECIALTY VENEER ACCENTS**

**CROTCH MAHOGANY INFIELD WITH MITERED BORDER**



**STYLE NUMBER**

- TCB-1 - 84 x 36/42
- TCB-2 - 72 x 36/42
- TCB-3 - 72 x 30/36

**LIST PRICE**

- 1895
- 1795
- 1695

**SPECIFICATIONS**

- Center balanced butt and book matched crotch mahogany
- 35 sheen non-rubbed finish ensures maximum durability

Available: - Jamestown, Prado

**SPECIALTY VENEER ACCENTS**

**CROTCH MAHOGANY DESK PEDESTAL FRONTS**

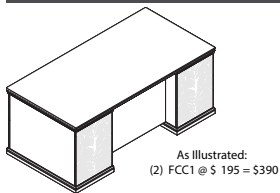

Desk Approach  
Pedestal Fronts

**STYLE NUMBER**

FCC1

**LIST PRICE**

195 per pedestal

**SPECIFICATIONS**

- Center balanced butt and book matched crotch mahogany
- 35 sheen non-rubbed finish ensures maximum durability

Available: - Jamestown, Prado

**SPECIALTY VENEER ACCENTS**

**CROTCH MAHOGANY DRAWER FRONTS**

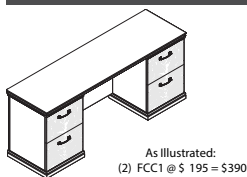

Box/Box/File or File/File  
Drawer Fronts

**STYLE NUMBER**

FCC1

**LIST PRICE**

195 per pedestal

**SPECIFICATIONS**

- Center balanced butt and book matched crotch mahogany
- 35 sheen non-rubbed finish ensures maximum durability

Available: - Jamestown, Prado

**SPECIALTY VENEER ACCENTS**

**CROTCH MAHOGANY DOUBLE WIDTH PANEL FRONTS**



All Three Illustrations Represent: (1) FCC2 @ \$395

30-32-36 Width  
FCC-2 \$395 per Panel Set

**STYLE NUMBER**

FCC2

**LIST PRICE**

395 per Panel Set

**SPECIFICATIONS**

- Center balanced butt and book matched crotch mahogany
- 35 sheen non-rubbed finish ensures maximum durability

Available: - Jamestown, Prado

**SPECIALTY VENEER ACCENTS**

**CROTCH MAHOGANY DOUBLE WIDTH/ DOUBLE HEIGHT FRONTS**



**STYLE NUMBER**  
FCC3

**LIST PRICE** 895 per Panel Set  
**SPECIFICATIONS**  
 - Center balanced butt and book matched crotch mahogany  
 - 35 sheen non-rubbed finish ensures maximum durability

Both Illustrations Represent:  
 (1) FCC3 @ \$895 - Panel Set  
 30-36 Width  
 FCC-3 \$895 per Panel Set

Available: - Jamestown, Prado

**SPECIALTY VENEER ACCENTS**

**RECTANGLE INLAY - RECESSES DURA-LEATHER WRITING SURFACE**



RECTANGLE INLAY

**STYLE NUMBER**  
RL-29A

**LIST PRICE** 895  
**SPECIFICATIONS**  
 - Recessed inlay desk pads are covered with Alomost Leather from Paul Brayton Designs.  
 - DARRAN will gladly custom quote other inlay materials ie: solid surfaces, biocomposites, metallic laminates, or genuine leather to match seating

Available: - All DARRAN Collections

**SPECIALTY VENEER ACCENTS**

**BOWFRONT INLAY - RECESSES DURA-LEATHER WRITING SURFACE**

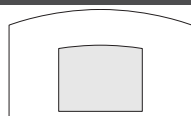

BOWFRONT INLAY

**STYLE NUMBER**  
RL-31A

**LIST PRICE** 995  
**SPECIFICATIONS**  
 - Recessed inlay desk pads are covered with Alomost Leather from Paul Brayton Designs.  
 - DARRAN will gladly custom quote other inlay materials ie: solid surfaces, biocomposites, metallic laminates, or genuine leather to match seating

Available: - All DARRAN Collections

**SPECIALTY VENEER ACCENTS**

**RECTANGLE INLAY - EBONY HARDWOOD INLAY DETAIL**



RECTANGLE INLAY

**STYLE NUMBER**  
T10SA

**LIST PRICE** 895  
**SPECIFICATIONS**  
 - 3/16" x 3/16" thick hardwood ebony inlay is handfitted and glued into routed top and sanded flush with surface  
 - Inlay is finished over with all finish steps

**Notes**  
 - Ebony inlay not recommended in: Koko Cherry

Available: - All DARRAN Collections

**SPECIALTY VENEER ACCENTS**

**BOWFRONT INLAY - EBONY HARDWOOD INLAY DETAIL**

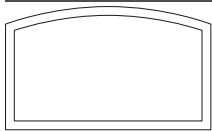

CURVED INLAY

**STYLE NUMBER**  
T11SA

**LIST PRICE**  
995

**SPECIFICATIONS**  
- 3/16" x 3/16" thick hardwood ebony inlay is handfitted and glued into routed top and sanded flush with surface  
- Inlay is finished over with all finish steps

**Notes**  
- Ebony inlay not recommended in: Koko Cherry

Available: - All DARRAN Collections

**TOOL CHANNEL ACCESSORIES**

**RECESSED ALUMINUM TOOL CHANNEL**

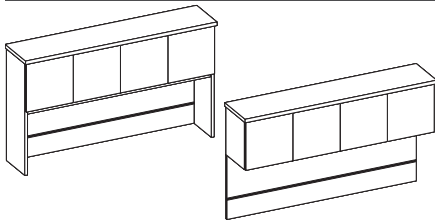

**STYLE NUMBER**  
ATB02

**LIST PRICE**  
5 per 1"W

**SPECIFICATIONS**  
- Anodized aluminum finish  
- Fully recessed  
- Finish matches anodized aluminum accessories  
- Can be specified with fabric tack surface mounted above channel

**Notes**  
- If using tool channel with wallhung overhead, a veneer panel must be specified.

Available: - All DARRAN Collections. Excludes Rail.

**TOOL CHANNEL ACCESSORIES**

**FILE HOLDER**

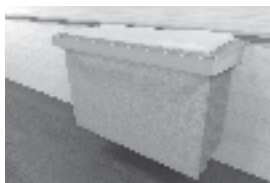

**STYLE NUMBER**  
ATB37

**LIST PRICE**  
105

**SPECIFICATIONS**  
- For Console/Wall Hung Back Panels With Optional Tool Bar  
- 18 Gauge Steel - Stamp Formed  
- Silver Powderdercoat Finish

Available: - All DARRAN Collections. Excludes Rail.

**TOOL CHANNEL ACCESSORIES**

**IPHONE HOLDER**



**STYLE NUMBER**  
ATB31

**LIST PRICE**  
120

**SPECIFICATIONS**  
- For Console/Wall Hung Back Panels With Optional Tool Bar  
- 18 Gauge Steel - Stamp Formed  
- Silver Powderdercoat Finish  
- 5" x 3 -3/4"W  
- Non-slip Neoprene pad

Available: - All DARRAN Collections. Excludes Rail.

**TOOL CHANNEL ACCESSORIES**

**LARGE SHELF**

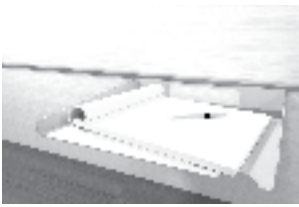

**STYLE NUMBER**  
ATB35

**LIST PRICE**  
125

**SPECIFICATIONS**  
- 12"W x 10"D

Available: - All DARRAN Collections. Excludes Rail.

**TOOL CHANNEL ACCESSORIES**

**PENCIL PEN HOLDER**



**STYLE NUMBER**  
ATB38

**LIST PRICE**  
115

**SPECIFICATIONS**  
- For Console/Wall Hung Back Panels With Optional Tool Bar  
- 18 Gauge Steel - Stamp Formed  
- Silver Powdercoat Finish  
- 5"H x 4"W x 4"D

Available: - All DARRAN Collections. Excludes Rail.

**TOOL CHANNEL ACCESSORIES**

**SMALL SHELF**



**STYLE NUMBER**  
ATB36

**LIST PRICE**  
110

**SPECIFICATIONS**  
- 12"W x 6 -3/4"D

Available: - All DARRAN Collections. Excludes Rail.

**TOOL CHANNEL ACCESSORIES**

**TABLET HOLDER**

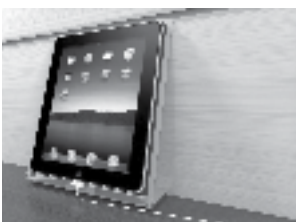

**STYLE NUMBER**  
ATB30

**LIST PRICE**  
135

**SPECIFICATIONS**  
- For Console/Wall Hung Back Panels With Optional Tool Bar  
- 18 Gauge Steel - Stamp Formed  
- Silver Powdercoat Finish  
- 10" x 8"W  
- Non-slip Neoprene pad

Available: - All DARRAN Collections. Excludes Rail.

TOP MODIFICATION

1/4" RECTANGLE SOFT ETCH GLASS RUNOFF WORKSURFACE

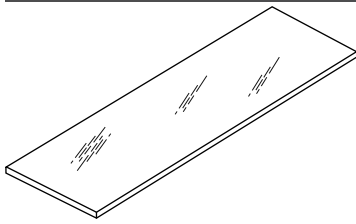

STYLE NUMBER

SEGW8436  
 SEGW8430  
 SEGW7836  
 SEGW7830  
 SEGW7230  
 SEGW6630  
 SEGW6030

LIST PRICE

2210  
 1870  
 2070  
 1750  
 1630  
 1515  
 1395

SPECIFICATIONS

- 1/4" Soft etch glass
- Back painted white glass

Notes

- Additional colors can be custom quoted. Contact factory for pricing.

Available: - Rift Runoff Worksurface

TOP MODIFICATION

TOP APRON RAIL

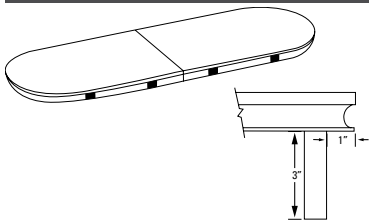

STYLE NUMBER

TAR

LIST PRICE

Add 10% to top price for apron only

SPECIFICATIONS

- 3 x 3/4 thick apron rail is set back under top 1"
- Apron rail is recommended for fixed port installation for power/data support.

Notes

- Select power/data support separately.
- See power options for available apron power: UDT2/VD-SM

Available: - Conferencing Tops Only

TOP MODIFICATION

TOP APRON RAIL



STYLE NUMBER

TAR-M

LIST PRICE

Add 15% (Apron rail with beltline detail)

SPECIFICATIONS

- Traditional with apron rail and molding - available in Cherry and Walnut.

Notes

- Select power/data support separately.
- See power options for available apron power: UDT2/VD-SM

Available: - Conference tops only

WIRE MANAGEMENT

HORIZONTAL J-CHANNEL WIRE MANAGEMENT RACEWAY

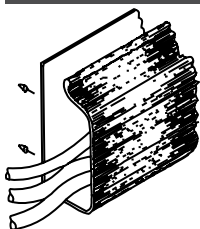

STYLE NUMBER

W1

LIST PRICE

75 Per 4 Foot Section

SPECIFICATIONS

- 4' section for field installation.
- The "J" shape black thermoplastic wire raceway may be added to specified worksurface tops to provide concealed channeling of wires to and from worksurface grommets. For use in open kneespace areas, raceway is attachable to top of back panel with pan head screws. Interior dimensions are 1" x 1- 1/2" providing ample storage for multiple wires and excess cable. Front of raceway flexes out for easy cord insertion.

Notes

- Units w/ Wire Channel Standard.
- Field Installation

Available: - All DARRAN Collections.

WIRE MANAGEMENT

HORIZONTAL U-CHANNEL WIRE MANAGEMENT RACEWAY



STYLE NUMBER

W2A

LIST PRICE

75 Per 4 Foot Section

SPECIFICATIONS

- 4' section for field installation.

Notes

- Units w/ Wire Channel Standard.
- Field Installation

Available: - All DARRAN Collections.

WIRE MANAGEMENT

COIL WIRE MANAGER



STYLE NUMBER

W18

LIST PRICE

150

SPECIFICATIONS

- Weighted Base, Table attachment plate
- 39- 1/2" Length
- Black

Notes

- Location

Available: - All DARRAN Collections.

WIRE MANAGEMENT

STANDARD LOCATION GROMMETS - FACTORY INSTALLED

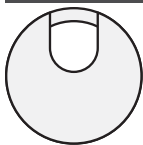

STYLE NUMBER

*Standard Location Grommet*

*Black*

TM30

*Silver*

TM31

*Antique Brass*

TM33

*White*

TM34

LIST PRICE

45

45

45

45

SPECIFICATIONS

- 1 -5/8" Metal Grommet

Notes

- \*Units w/ Grommets Standard Are Noted Under Standard Features. Grommets Match Pull Finish - Standard (Unless Specified Otherwise)

Available: - All DARRAN Collections.

WIRE MANAGEMENT

NON-STANDARD LOCATION GROMMETS - FACTORY INSTALLED

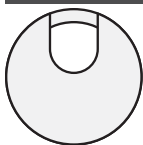

STYLE NUMBER

*Non-Standard Location Grommet*

*Black*

TM30 -NS

*Silver*

TM31 -NS

*Antique Brass*

TM33 -NS

*White*

TM34 -NS

LIST PRICE

90

90

90

90

SPECIFICATIONS

- 1 -5/8" Metal Grommet

Notes

- \*Units w/ Grommets Standard Are Noted Under Standard Features. Grommets Match Pull Finish - Standard (Unless Specified Otherwise)

Available: - All DARRAN Collections

**WIRE MANAGEMENT**

**BLACK PLASTIC VERTICAL SURFACE GROMMETS - FACTORY INSTALLED**



STYLE NUMBER	LIST PRICE	SPECIFICATIONS
<i>Standard Location Grommet</i>		- 2 " Black Plastic Grommet
TM50-C	45	<b>Notes</b> - Standard Location is Bottom Center
<i>Non-Standard Location Grommet</i>		
TM50-NS	90	

Available: - All DARRAN Collections

**WORKSTATION**

**CLIENT PULLOUT WRITING SHELF**

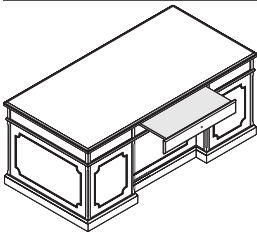

STYLE NUMBER	LIST PRICE	SPECIFICATIONS
CP-1	425	- CP-1: Client pull-out writing shelf for executive chassis desk
CP-2	625	- CP-2: Client pull-out writing shelf for conference desk

Available: - Jamestown

**AIRCHARGE WIRELESS CHARGING GROMMET**

STYLE NUMBER	LIST PRICE
 ACWG WIRELESS GROMMET	\$575
ACWR WIRELESS RECEIVER W/ LIGHTNING CABLE	\$170



**SPECIFICATIONS**

- AirCharge offers a convenient way to charge any Qi compatible smartphone or device without the need to carry charging cables or find an available power outlet. Devices not equipped with the Qi technology, can be adapted to accept a charge from the grommet with the AirCharge Wireless Receiver.
- Size: 3.33" DIA x .75"D
- Compatible with an Qi rated device, Contact Customer Service for compatibility list
- Non-Qi device can be adapted to accept AirCharge unit with an ACWR AirCharge Wireless Receiver (compatible with iPhone)
- Surface Mount
- 78" Cord
- Standard Black Aluminum Finish; Available in White Aluminum or Black Finish upon request

**AVAILABLE**

- All Darran Collections

AirCharge Wireless Grommet



iphone w/ ACWR



Black Aluminum



Black Finish



White Aluminum



## COVE POWER UNIT - NON-LINKING

STYLE NUMBER	LIST PRICE
 PD COVE PLUG Non-Linking Version	\$550

**SPECIFICATIONS**

- Size 5.75" L x 2.5" W
- (2) 15 Amp Receptacles and (2) USB charging ports
- Surface Mount
- 108" Cord
- Standard Silver Finish, Available in White or Black Finish upon request
- ETL Listed

**AVAILABLE**

- All Darran Collections



## COVE POWER UNIT WITH DAISYLINK

### STYLE NUMBER

### LIST PRICE

#### STARTER UNITS



#### COV-DCH HARDWIRED

\$710

Includes (1) Cove unit with Hardwire Infeed - 120"



#### COV-DCP PLUG

\$800

Includes (1) Cove unit with Plug infeed - Includes 72" Cord and 32" Infeed Jumper for 104" total cord infeed

#### ADDITIONAL LINKING UNITS

#### COV-DCL

\$575 EACH

Includes Linking Cove unit and Jumper up to 96", cable length determined by the top size

### SPECIFICATIONS

- Size: 5.75" L x 2.5" W
- (2) 15 Amp Receptacles and (2) 2.1 Amp USB charging ports
- Surface Mount
- Max Daisy Chain - Hardwire - (9) units; Plug/Corded - (4) units
- Standard Silver Finish, Available in White or Black Finish upon request
- ETL Listed

### AVAILABLE

- All Darran Collections



## COVE CORDED SERIES

STYLE NUMBER	LIST PRICE
 PD-COVE-PKO	\$800

**SPECIFICATIONS**

- Size 9.5" L x 2.5" W x 3.18" D
- (2) Power Receptacles, (2) 2.1 Amp USB charging ports and (1) Telecom Plate Knockout
- Surface Mount
- 108" Cord
- Standard Silver Finish, Available in White or Black Finish upon request
- ETL Listed

**AVAILABLE**



- All Darran Collections

**TELECOM PLATES**

*THIS POD CAN HAVE UP TO 1 TOTAL PLATES*

STYLE NUMBER	LIST PRICE
RJ45 (1)	\$35
RJ45 (2)	\$70
RJ45 (3)	\$105
USB (1)	\$70
USB (2)	\$140
RJ11/RJ45	\$70
RJ45/USB	\$105
RJ45/HDMI	\$190
HDMI/DVI	\$325
HDMI/USB	\$205
HDMI/VGA	\$240
VGA/MINI-STEREO	\$155
VGA/USB	\$175

## PDFAA FLUSH DATA BAY ANODIZED ALUMINUM DOOR

	STYLE NUMBER	LIST PRICE
	PDFAA-H Hardwired	\$1195
	PDFAA-C Plug	\$1195
	PDFAA-DC Daisy Chain	\$1395

Features convenience plug on bottom - Max Daisy chain (4) units  
 - Specify hardwired or plug for the first unit in series, daisy chained units will have a plug for connection through convenience plug.

## SPECIFICATIONS

- Size 13.75"L x 6.375"W x 2.85"D
- (4) 15 Amp receptacles
- Surface Mount
- Standard Interior Black Finish
- Specify up to (4) Telecom Plates; (2) on side and (2) on bottom
- Coded units are UL Listed and CSA Certified. Hardwired Units are CSA Certified



## AVAILABLE



- All Darran Collections
- Excludes Rail, Grove

## TELECOM PLATES

*THIS POD CAN HAVE UP TO 4 TOTAL PLATES*

STYLE NUMBER	LIST PRICE
RJ45 (1)	\$35
RJ45 (2)	\$70
RJ45 (3)	\$105
USB (1)	\$70
USB (2)	\$140
RJ11/RJ45	\$70
RJ45/USB	\$105
RJ45/HDMI	\$190
HDMI/DVI	\$325
HDMI/USB	\$205
HDMI/VGA	\$240
VGA/MINI-STEREO	\$155
VGA/USB	\$175

**PDFAF FLUSH DATA BAY FROSTED GLASS DOOR WITH DAISYLINK**

	STYLE NUMBER	LIST PRICE
	PDFAF-H HARDWIRED	\$1095
	PDFAF-C PLUG	\$1095
	PDFAF-DC DAISY CHAIN	\$1295

Features convenience plug on bottom - Max Daisy chain (4) units  
 - Specify hardwired or plug for the first unit in series, daisy chained units will have a plug for connection through convenience plug.



**SPECIFICATIONS**

- Size 13.75”L x 6.375”W x 2.85”D
- (4) 15 Amp receptacles
- Surface Mount
- Standard Interior Black Finish
- Specify up to (4) Telecom Plates; (2) on side and (2) on bottom
- Corded units are UL Listed and CSA Certified. Hardwired Units are CSA Certified

**AVAILABLE**

- All Darran Collections
- Excludes Rail, Grove



**TELECOM PLATES**

THIS POD CAN HAVE UP TO 4 TOTAL PLATES

STYLE NUMBER	LIST PRICE
RJ45 (1)	\$35
RJ45 (2)	\$70
RJ45 (3)	\$105
USB (1)	\$70
USB (2)	\$140
RJ11/RJ45	\$70
RJ45/USB	\$105
RJ45/HDMI	\$190
HDMI/DVI	\$325
HDMI/USB	\$205
HDMI/VGA	\$240
VGA/MINI-STEREO	\$155
VGA/USB	\$175

**REEF POWER UNIT WITH DAISYLINK**

**STYLE NUMBER**

**LIST PRICE**



REF310 PLUG

\$1100

**SPECIFICATIONS**

- Size 16.1”L x 6.25”W x 4.89”D
- (3) 120V Receptacles, (2) USB charging ports and (2) Knockouts for RJ45 Data Ports
- Surface Mount
- 108” Cord
- Features Convenience Plug on bottom of unit that allows for max (3) Daisy Chain
- Standard Black Finish, Available in White or Silver Finish upon request
- Additional Telecom Plate Knockout
- When used with Grove Tables an additional \$350 LIST will apply for the special cutout required.
- RJ45 for Knockouts not required. If not ordered a small hole will be present in this this location
- ETL Listed

**AVAILABLE**

- Grove
- Conferencing



**TELECOM PLATES**

*THIS POD CAN HAVE UP TO 1 TOTAL PLATES*

STYLE NUMBER	LIST PRICE
RJ45 (1)	\$35
RJ45 (2)	\$70
RJ45 (3)	\$105
USB (1)	\$70
USB (2)	\$140
RJ11/RJ45	\$70
RJ45/USB	\$105
RJ45/HDMI	\$190
HDMI/DVI	\$325
HDMI/USB	\$205
HDMI/VGA	\$240
VGA/MINI-STEREO	\$155
VGA/USB	\$175



## SECLUSION CORDED POWER UNIT NON-LINKING

## STYLE NUMBER

## LIST PRICE



P2SECL

\$245

Choose from plate mount or clamp mount (seen in photo)

## SPECIFICATIONS

- Size: 3.5"L x 2.2"D x 2.5"H
- (2) Power Receptacles
- Worksurface Clamp Mount or Plate Under Surface Mount
- Clamp Accessory accommodates table thickness up to 2"
- 72" Cord
- Standard Silver Finish, Black Finish available upon request
- UL/UCL Listed

## AVAILABLE

- All Darran Collections



Clamp Mount

**UDT POWER UNIT - NON-LINKING**

STYLE NUMBER	LIST PRICE
 <b>UDT2/VD-SM PLUG</b> Non-Linking	\$350



**SPECIFICATIONS**

- Size 6.5"L x 2.81"D x 1.26"H
- (2) Power receptacles and (1) Telecom Plate Cutout
- Side Mount, if Top Mount is required contact customer service
- 72" Cord
- Standard Black Powdercoat Finish
- Used in Apron Rails
- UL Listed

**AVAILABLE**

- Conferencing Apron Rails

**TELECOM PLATES**

*THIS POD CAN HAVE UP TO 1 TOTAL PLATES*

STYLE NUMBER	LIST PRICE
RJ45 (1)	\$35
RJ45 (2)	\$70
RJ45 (3)	\$105
USB (1)	\$70
USB (2)	\$140
RJ11/RJ45	\$70
RJ45/USB	\$105
RJ45/HDMI	\$190
HDMI/DVI	\$325
HDMI/USB	\$205
HDMI/VGA	\$240
VGA/MINI-STEREO	\$155
VGA/USB	\$175



## VILLA POWER UNIT - NON-LINKING

STYLE NUMBER	LIST PRICE
 VIL-C PLUG Non-Linking	\$515

## SPECIFICATIONS

- Size: Top Grommet 5.68"L X 3.39"W; Under Top 12"L x 3.13"W x 3.08"D
- (2) Power receptacles; (2) USB charging ports and (1) Knockouts for RJ45 Data Ports
- Surface Mount
- 72" Cord (Longer cord available, contact Customer Service)
- Standard Silver Finish, Black Finish available upon request
- UL or ETL Certified

## AVAILABLE

- All Darran Collections
- Excludes Grove

## RJ45 KNOCKOUT

STYLE NUMBER	LIST PRICE
RJ45 (1)	\$35



**VILLA POWER UNIT WITH DAISYLINK**

**STYLE NUMBER LIST PRICE**

**STARTER UNITS**



**VIL-DCH HARDWIRED** \$600  
Includes (1) Villa unit with 120" Hardwire Infeed



**VIL-DCP PLUG** \$695  
Includes (1) Villa with Plug Infeed - Includes 72" Cord and 32" Infeed Jumper for 104" total cord infeed

**ADDITIONAL LINKING UNITS**

**VIL-DCL ADDITIONAL** \$590  
(Includes linking Villa and Jumper cable up to 96")

**SPECIFICATIONS**

- Size: Top Grommet 5.68" L X 3.39"W; Under Top 12"L x 3.13"W x 3.08"D
- (4) Power receptacles; (2) surface and (2) undersurface, (2) 2.1A USB charging ports and (1) Knockout for RJ45 Data Port
- Surface Mount
- Daisy Chain - Hardwire Max (10) Units, Plug/Corded Max (5) Units
- Standard Silver Finish, Black Finish available upon request
- UL or ETL Certified

**AVAILABLE**

- All Darran Collections
- Excludes Grove



**RJ45 KNOCKOUT**

STYLE NUMBER	LIST PRICE
RJ45 (1)	\$35